

BLANKETROL® III

Operation Manual Model 233 Hyper-Hypothermia System



GENTHERM

Gentherm Medical, LLC • 12011 Mosteller Road • Cincinnati, Ohio 45241, U.S.A.

www.gentherm.com

BLANKETROL® is a registered trademark of Gentherm Medical, LLC, Cincinnati, Ohio USA

Copyright 2026, Gentherm Medical, LLC All rights reserved.

Manual 57201 Rev. AH

TECHNICAL HELP

United States and Canada
Gentherm Medical, LLC
12011 Mosteller Road
Cincinnati, OH 45241
www.gentherm.com

Telephone	1-513-772-8810
(U.S.) Toll Free	1-800-989-7373
(U.S.) 24hr Clinical Support	1-513-460-2038
Fax	1-513-772-9119

BEFORE YOU CALL FOR SERVICE...

To help us better serve you, please have the serial number of your BLANKETROL III unit ready when you call for parts or service. The serial number is located on a specification label attached to the unit's rear panel.

How to read serial numbers:

Example: 121-3-60000

- 12 indicates a manufacturing date of the year 2012
- 1 indicates the quarter (first)
- -3- means BLANKETROL III, Model 233
- 60000 indicates that this is the 60,000th unit of a certain model

IN-WARRANTY REPAIR AND PARTS

All parts on your BLANKETROL III unit are covered by a two-year (2) warranty. Additional third year warranty is available at the time of purchase. To return defective parts or units, first obtain a Returned Materials Authorization (RMA) number from our Medical Technical Service department. All returns should be made using GENTHERM-issued shipping cartons.

IMPORTANT SAFETY INFORMATION

Refer to this manual for instructions and operator information. Read and understand all WARNINGS / CAUTIONS before using, prescribing, or servicing the BLANKETROL III System

TABLE OF CONTENTS

TECHNICAL HELP	2
BEFORE YOU CALL FOR SERVICE.....	2
IN-WARRANTY REPAIR AND PARTS	2
IMPORTANT SAFETY INFORMATION	2
SECTION 1. INTRODUCTION.....	9
1-0. GENERAL SAFETY PRECAUTIONS.....	9
1-1. GENERAL DESCRIPTION OF THE BLANKETROL III SYSTEM	9
1-2. PHYSICAL DESCRIPTION OF THE BLANKETROL III UNIT	9
1-2.1. <i>External Features - Front View</i>	10
1-2.2. <i>External Features – Right Side View</i>	11
1-2.3. <i>External Features – Rear View</i>	12
1-2.4. <i>Description of the BLANKETROL III Membrane Control Panel</i>	13
1-3. REQUIRED ACCESSORIES.....	14
1-4. USB PORT OPERATION	14
1-5. FUNCTIONAL DESCRIPTION OF THE BLANKETROL III SYSTEM	15
1-5.1. <i>Theory of Operation</i>	15
SECTION 2. GENERAL PREPARATION OF THE BLANKETROL III SYSTEM.....	18
2-1. INTRODUCTION	18
2-2. UNPACKING THE SHIPMENT.....	18
2-3. FIRST TIME SET-UP/SYSTEM TEST ROUTINE	18
2-3.1. <i>Inspecting and Arranging the Equipment</i>	18
2-3.2. <i>Complete a System Test Routine</i>	19
2-4. UNIT AND PATIENT RELATED PRECAUTIONS.....	19
2-5. PATIENT PREPARATION AND BEDSIDE CARE.....	19
SECTION 3. OPERATING THE BLANKETROL III SYSTEM.....	20
3-1. INTRODUCTION	20
3-2. ARRANGING THE SYSTEM COMPONENTS.....	20
3-3. OPERATING THE BLANKETROL III SYSTEM IN <i>AUTO CONTROL MODE</i>	22
3-4. OPERATING THE BLANKETROL III SYSTEM IN <i>MANUAL CONTROL MODE</i>	24
3-5. OPERATING THE BLANKETROL III SYSTEM IN <i>MANUAL CONTROL MODE</i> WITH THE ADDITION OF THE PATIENT PROBE.....	25
3-6. OPERATING THE BLANKETROL III UNIT IN <i>GRADIENT 10C SMART MODE</i>	26
3-7. OPERATING THE BLANKETROL III SYSTEM IN <i>GRADIENT VARIABLE SMART MODE</i>	28
3-8. OPERATING THE BLANKETROL III SYSTEM IN <i>MONITOR ONLY MODE</i>	30
3-9. CONCLUDING HYPER-HYPOTHERMIA TREATMENT	30
3-10. STATUS DISPLAY MESSAGES	31
SECTION 4. GENERAL MAINTENANCE OF THE BLANKETROL III SYSTEM	35
4-1. INTRODUCTION	35
4-2. MAINTENANCE OF THE BLANKETROL III EXTERIOR – CLEANING INSTRUCTIONS	35
4-3. MAINTENANCE OF THE WATER RESERVOIR.....	35
4-3.1. <i>Draining the Reservoir</i>	37
4-3.2. <i>Replenishing the Reservoir</i>	38
4-4. MAINTENANCE OF THE HYPER-HYPOTHERMIA BLANKETS	38
4-4.1. <i>Reusable Blankets</i>	38
4-4.2. <i>Disposable, Single-Patient Use Blankets</i>	38
4-5. MAINTENANCE OF REUSABLE THERMISTOR PROBES	38
4-6. DISPOSAL OF THE BLANKETROL III UNIT	38
SECTION 5. SPECIFICATIONS AND CERTIFICATIONS OF THE BLANKETROL III.....	39
WORLDWIDE ORDER PLACEMENT	43

FIGURES AND TABLES

FIGURE 1-1. BLANKETROL III – FRONT VIEW 10

FIGURE 1-2. BLANKETROL III – RIGHT SIDE VIEW 11

FIGURE 1-3. BLANKETROL III – REAR VIEW 12

FIGURE 1-4.A. BLANKETROL III – MEMBRANE CONTROL PANEL (ENGLISH) 13

FIGURE 1-4.B. BLANKETROL III – MEMBRANE CONTROL PANEL (SYMBOLS) 14

TABLE 5-1. GUIDANCE AND MANUFACTURER'S DECLARATION - ELECTROMAGNETIC EMISSIONS 41













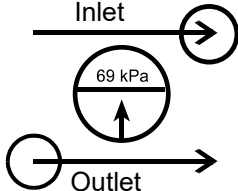

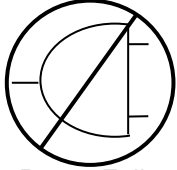







TABLE 5-2. GUIDANCE AND MANUFACTURER'S DECLARATION - ELECTROMAGNETIC IMMUNITY 41

TABLE 5-3. GUIDANCE AND MANUFACTURER'S DECLARATION - ELECTROMAGNETIC IMMUNITY 42

**TABLE 5-4. RECOMMENDED SEPARATION DISTANCE BETWEEN PORTABLE AND MOBILE RF COMMUNICATIONS
EQUIPMENT AND THE BLANKETROL III, MODEL 233..... 43**

BLANKETROL[®] III

Symbol Definitions

			
Read Operation Instructions and Manual Before Operating	Temperature Set	Gradient 10° C	Gradient Variable
			
INCREMENT (Increase Temperature)	DECREMENT (Decrease Temperature)	Automatic Control	Manual Control
			
Monitor Only	Test Indicators	Water Temperature	Patient Temperature
			
Water Flow Indicator	Fill to Strainer		Low Water Level
			
Risk of Explosion: Do not use in the Presence of Flammable Anesthetics	Disconnect Power Before Servicing	Danger; Risk of Electric Shock	Power Failure
			
ESD Susceptibility	Separate Disposal for Electrical / Electronic Equipment	Type BF Equipment	Medical Device
			
OFF / ON Switch	OFF / ON Switch	Equipotential Symbol	AC Voltage
			
			USB Port: Insert Port in This Direction

BLANKETROL® III OPERATION MANUAL

Gentherm Medical, LLC reserves the right to make equipment changes and improvements, which may not be reflected in this manual.

WARNING

- A physician's order is required for setting blanket temperature and use of equipment. At least every 20 minutes, or as directed by physician, check patient's temperature and skin integrity of areas in contact with blanket; also, check the BLANKETROL III's water temperature. Pediatric patients, temperature-sensitive patients with vascular disease, surgical patients, diabetics and patients with Raynaud's Disease are at greater risk for developing tissue injuries, and this should be considered when selecting the temperature, duration of therapy and frequency of skin checks. **Notify the physician promptly of any change in patient status in order to avoid serious injury or death.**
- The method of temperature control provided by all hyper-hypothermia units presents the danger of heating or cooling body tissues, particularly the skin, to a point where they are injured, i.e., burns or frostbite, respectively. The clinician is responsible for determining the appropriateness of the temperature limits in dependency to time. **Exceeding 40°C water temperature for extended periods can cause tissue damage and burns. Clinical judgment should be used to determine the safe maximum contact periods based on patient age, clinical condition, and current medications. Depending on the extent and severity of a burn, very serious and even fatal complications may arise.**
- Do not use the BLANKETROL III System distal to arterial cross clamping. **Thermal injury may result.**
- **Thermal injury may occur** if heating/cooling therapy is applied to ischemic limbs.
- The warming of transdermal medications (patches) can increase drug delivery, **resulting in possible injury to the patient.**
- Prevent excessive and/or prolonged tissue pressure and shearing forces, especially over bony prominences. **Failure to do so may result in tissue injury.**
- Do not place additional heat sources between the patient and blanket. **Tissue damage may result.**
- Means to maintain contact between the patient and the blanket during therapy may be required and should not block the fluid pathways of the blanket or connecting hose. **Failure to do so may result in inadequate treatment.**
- Prep solutions have been reported to injure the skin when allowed to remain between patients and a water-circulating heating blanket during prolonged procedures. Use of materials of good thermal conductivity, such as water, gel, and similar substances, with the BLANKETROL III not switched ON may decrease the temperature of the patient. **The area between the patient and the blanket should be kept dry to avoid injury to patient.**
- Proper sanitation procedures must be practiced and hygienic safety must be maintained, to prevent contamination. **Contamination can affect patient's health, i.e. skin irritation/rash may result.**
- Use only YSI 400 Series, or equivalent, probes on GENTHERM equipment. **Failure to do this will cause incorrect temperature readings and may result in inadequate/inappropriate treatment.**
- Due to static electricity, a 400 Series Probe may not be connected to the BLANKETROL III unit without first discharging one's body to the frame of the BLANKETROL III unit or another grounded object. **Failure to do so may result in damage from electrostatic discharge (ESD).** All staff that may touch the 400 Series Probe must be familiar with this warning and basic static electricity or electrostatic discharge (ESD) training.
- Basic static electricity or ESD training should include an introduction to the physics of electrostatic charge, the voltage levels that can occur in normal practice and the damage that can be done to electronic components if equipment is touched by an operator who is electrostatically charged. Further, an explanation should be given of methods to prevent build-up of electrostatic charge, and how and why to discharge one's body to the BLANKETROL III unit or another grounded object. **Failure to do so may result in damage from electrostatic discharge (ESD).**
- Do not use the BLANKETROL III system in the presence of flammable anesthetics. **Risk of explosion can result.**
- Power interruption will cause the BLANKETROL III to revert to **CHECK SET POINT** resulting in no therapy to the patient. Follow instructions for desired mode to resume operation. **Failure to resume therapy could result in serious injury or death.**
- **Do not by-pass ground lug (230V System). Electrical Hazards may result.**
- To avoid the risk of electric shock, this equipment must only be connected to a supply mains with protective earth. **Risk of electrical shock may occur.**
- **Blanket punctures can result in an increased risk of infection or electrical shock.** Inspect all blankets for mechanical damage before use. Do not use in proximity to sharp objects.
- Any time water is found leaking into or around the unit, connecting hose, and/or blanket, turn the unit off, disconnect the power cord from its power source, and correct the problem before proceeding. Proper maintenance procedures should be followed including, but not limited to, the preventative maintenance described in this manual. Leaky blankets or hoses should never be used. **Water leaks could present a slip hazard and risk of infection and could lead to electric shock.**

WARNING

<ul style="list-style-type: none"> Exercise extreme caution if the BLANKETROL III System is used on patients with cardiac issues, for example, patients with pacemakers, or when a probe is inserted in or attached to the patient. Failure to properly monitor patient may result in serious injury or death.
<ul style="list-style-type: none"> Due to electromagnetic compatibility, the BLANKETROL III unit should not be used adjacent to or stacked with other equipment. Potential electromagnetic interference may result. Other equipment includes ventilators, patient monitors, anesthesia delivery equipment, etc. Electromagnetic interference refers to electronic devices unintentionally affecting the operation of each other by emitting electromagnetic energy. Unit complies with IEC 60601-1-2.
<ul style="list-style-type: none"> If the BLANKETROL III unit or the other equipment is not operating normally, remove the device from service and have a biomedical or service technician observe the device in operation. Refer to Section 5 for recommended separation distances between other equipment and the BLANKETROL III. Failure to do so may result in damage to the BLANKETROL III system and patient injury.
<ul style="list-style-type: none"> Always unplug the unit before accessing internal components during service. Failure to unplug the unit could result in electric shock.
<ul style="list-style-type: none"> The repair, calibration, and servicing of the BLANKETROL III should be performed by qualified Medical Equipment Service Technicians, Certified Biomedical Electronics Technicians, or Certified Clinical Engineers familiar with good repair practices for servicing medical devices, and in accordance with instructions contained in this manual. Improper repair can result in damage to the BLANKETROL III system and patient injury.
<ul style="list-style-type: none"> No modification of this equipment is allowed without prior, written authorization from GENTHERM. Failure to do so may result in damage to the BLANKETROL III system and patient injury.
<ul style="list-style-type: none"> Before returning the BLANKETROL III to patient use after repairs, the FIRST TIME SET-UP/SYSTEM TEST ROUTINE in Section 2 must always be performed. Improper repair and inadequate maintenance can result in damage to the BLANKETROL III system and patient injury.
<ul style="list-style-type: none"> Remove the BLANKETROL III from service if the outer casing or membrane control panel is cracked or internal components are exposed. Contact with internal components could result in electric shock or thermal injury to the patient or operator and exposure to sharp edges.
<ul style="list-style-type: none"> Keep grill and condenser clean and free of debris and obstruction. Blockage of the grill and condenser could result in the unit overheating which could render the unit unable to provide adequate therapy and excessive surface temperatures could cause injury of patient or operator. Keep unit, specifically the grill away from curtains or other obstructions.
<ul style="list-style-type: none"> The USB connection on the BLANKETROL III unit is intended for data transfer to a computer. Any other uses/connections may result in damage to the BLANKETROL III unit.
<ul style="list-style-type: none"> Working with electronic boards, plugs, and cables requires delicate handling. Proper electrostatic discharge (ESD) procedures should be followed during replacement of any electronic board. Failure to do so may result in damage to the board.
<ul style="list-style-type: none"> Use of accessories other than those specified in the Operation and Technical Manual may result in increased electromagnetic emissions or decreased immunity to electromagnetic emissions of the BLANKETROL III unit. This could affect the BLANKETROL III's compatibility with other electrical equipment. Electromagnetic compatibility refers to electronic devices unintentionally affecting the operation of each other by emitting electromagnetic energy.

CAUTION

- Federal law restricts this device to sale by or on the order of a physician.
- **Use Sterile water or water that has been passed through a filter less than or equal to 0.22 microns only. Do Not Use De-ionized water or Distilled Water. De-ionized water** may cause corrosion to plumbing system components. **Do Not Use Tap Water. Minerals and deposits** can clog plumbing system components.
- **Do not** use alcohol. Alcohol may cause blanket and unit deterioration.
- Use only hospital grade plug or electric shock may result.
- **Do not** overfill. Overfilling may result in overflow when the water in the blanket drains back into the system when the system is turned off.
- Always drain the BLANKETROL III to a sanitary drain because **bio-contaminants** may be present in the unit's water supply.
- Handling or use of the patient probe may result in damage from **electrostatic discharge (ESD)** if proper precautions are not taken.
- All wire-lead, patient-connected transducer assemblies are subject to reading error, local heating, and possible damage from high intensity sources of RF energy. Inadequately grounded electrosurgical equipment represents one such source, since capacitively coupled currents may seek alternate paths to ground through probe cables and associated instruments. Patient burns may result. If possible, remove the probe from patient contact before activating an electrosurgical unit.
- **Do not** immerse probes or connecting cables in liquid. Failure to do so may result in damage to the probes.
- If the unit was shipped on its side, permit the unit to rest in an upright position for twelve (12) hours before operating due to refrigeration oil displacement.
- For safe handling and use of chemicals follow manufacturer guidelines.
- Do not make any connection to the USB port terminal while the device is also connected to a patient. Do not touch this connector and the patient at the same time. Patient injury may result.
- Users should not use cleaning or decontamination methods different from those recommended by GENTHERM without first checking with GENTHERM that the proposed methods will not damage the equipment.
- Working with electronic boards, plugs, and cables requires delicate handling. Proper **electrostatic discharge (ESD)** procedures should be followed during replacement of any electronic board. **Failure to do so may result in damage to the board.**
- If device is set to operate in any Automatic mode, the device will shut down and activate the CHECK PROBE alarm if the patient temperature falls below 30.0°C (86°F). Patient temperature must rise above 30.0°C (86°F) before restarting the device in Automatic mode. The device can be operated in Manual Control mode in order to warm the patient above 30.0°C (86°F). Potential for interruption of therapy.
- **Unapproved blankets or hose should never be used.**
- **Do not use GRADIENT VARIABLE MODE OR Gradient 10C MODE without SMART MODE. Unintended therapy could occur.**

SECTION 1. INTRODUCTION

1-0. GENERAL SAFETY PRECAUTIONS

To provide the patient maximum safety during the use of the BLANKETROL III Hyper-Hypothermia System, a thorough knowledge and understanding of the system, and its correct application and operating use are required. Each person who is responsible for use or direction of use of the system, such as physicians, nurses, technicians and operators must read and understand this operating manual and all precautions and warnings prior to use. It is recommended this manual be read at least semi-annually as a refresher for safe operation and application. **For proper knowledge and understanding, in-service is available upon request.**

1-1. GENERAL DESCRIPTION OF THE BLANKETROL III SYSTEM

INDICATIONS FOR USE

The BLANKETROL III Hyper-Hypothermia Temperature Management System is used to lower or to raise a patient's temperature and/or maintain a desired patient temperature through conductive heat transfer. The system is composed of a heater, a compressor, a circulating pump and blankets/pads.

BLANKETROL III Model 233

This unit requires no field adjustments or calibrations in order to maintain the precise board measurement of temperature and temperature limits.

Sterile water or water that has been passed through a filter less than or equal to 0.22 microns is heated or cooled and pumped from the unit to a blanket. The blanket* rests under and/or on top of the patient and is designed so that the water circulates through the blanket and returns to the unit.

If water that is at a lower temperature than the patient's temperature is circulated through the blanket, the desired effect is to reduce the patient's temperature. If water that is at a higher temperature than the patient's temperature is circulated through the blanket, the desired effect is to elevate the patient's temperature.

The BLANKETROL III unit can be set so that it operates based on the temperature of the water in the BLANKETROL III equipment (*MANUAL CONTROL MODE*) or it can be set so that it operates based upon the patient's temperature (Automatic Modes). The three Automatic modes include:

- 1) *AUTO CONTROL MODE*
- 2) *GRADIENT 10C SMART MODE*
- 3) *GRADIENT VARIABLE SMART MODE*

The BLANKETROL III System can also be used solely to monitor the temperature of the patient (*MONITOR ONLY MODE*).

The BLANKETROL III is intended for use in ambient temperatures of 15°C – 30°C (59°F – 86°F). The maximum contact surface temperature is 41°C (105.8°F).

* The recommended blanket(s) for use are described in the Operation and Technical Manual

1-2. PHYSICAL DESCRIPTION OF THE BLANKETROL III UNIT

See Section (5) for specifications and certifications of the BLANKETROL III.

1-2.1. External Features - Front View

The external features in Figure (1-1) of the BLANKETROL III unit are described as follows:

- A. The control panel is composed of pressure sensitive touch switches, nine LED indicators, a liquid crystal display, and two LED displays. An expanded description of the membrane control panel is presented in Section (1-2.4)
- B. The recessed handle permits the operator to grip the unit when moving it.
- C. The power switch is a bevel rocker switch labeled "I" (on) at the top and "O" (off) at the bottom. The switch illuminates green when the unit is on. A circuit breaker is built into the switch to protect against overload conditions.
- D. The storage drawer tilts out from the top to provide storage space for items such as probes, connecting cables, connecting hoses, the drain hose, and the Operation Manual.
- E. The grill permits air to be drawn into the unit and pass over the condenser. The air is then discharged through the bottom of the unit. The grill and compressor should be kept clear from blockage and cleaned regularly as described in the Operation and Technical Manual.
- F. The protective bumper guard surrounds the lower edge of the unit and protects the unit as well as the walls.
- G. Four swivel casters are specially designed to permit the unit to move easily and to prevent it from tipping. The casters are equipped with locking features to prevent unintended movement during operation.

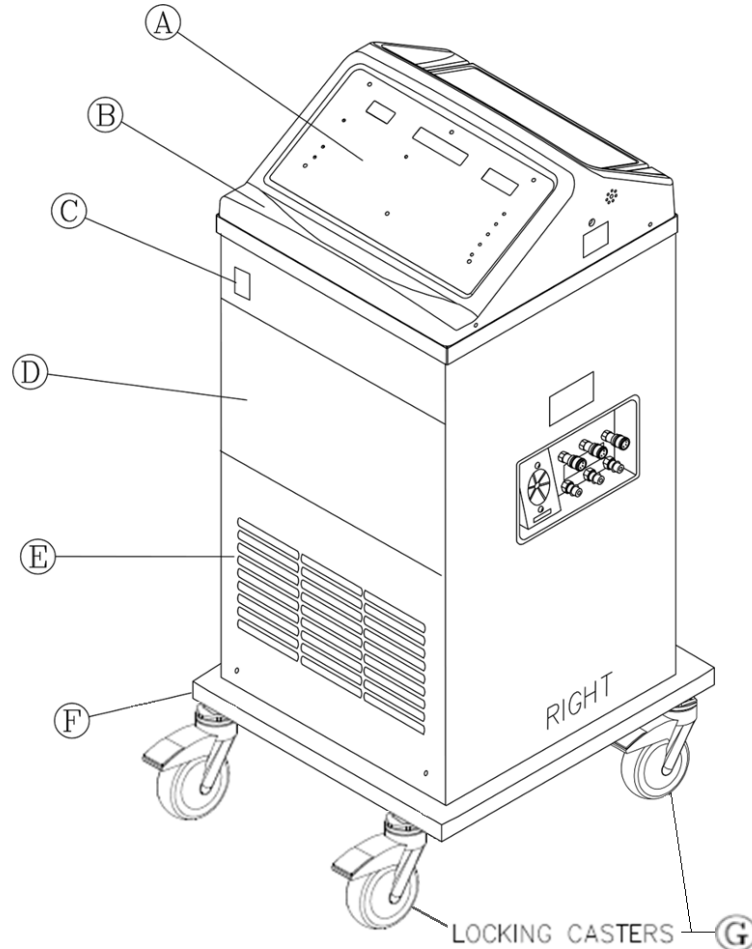

FIGURE 1-1. BLANKETROL III – FRONT VIEW

1-2.2. External Features – Right Side View

The external features in Figure (1-2.) of the BLANKETROL III unit are described as follows:

- A. The water flow indicator is a paddle wheel immersed in the path of the circulating water with a window to the outside. As water is circulated through the system, it passes over the paddle wheel causing it to spin (like a pinwheel). The water flow indicator provides a visual display of the general rate at which the water is circulating. For example, if the unit is circulating water but the connecting hose is pinched, the circulation of the water is restricted. The restriction in water flow decreases the speed of the paddle wheel. A total obstruction of the water path will cause the paddle wheel to stop completely.

The water flow indicator only spins when a blanket or by-pass hose is connected to the unit. It will not spin while the water is being circulated internally to pre-condition the water to the 'preset" water temperature chosen by the operator.
- B. The air vents, on both the right and left side of the unit, provide air circulation for the microprocessor.
- C. The four capped screws on the right and left side of the unit secure the top to the base.
- D. The patient 1/4 inch receptacle is where the 400 Series probe is connected to the unit. Only one patient probe can be connected at a time.
- E. Three female, quick-disconnect return couplings on the top row are designed for water to flow in when the male coupling of the connecting hose is attached.
- F. The three male quick-disconnect outlet couplings on the bottom row are designed for water to flow out when the female coupling of the connecting hose is attached.
- G. The power cord with a hospital-grade plug should only be plugged into a properly grounded hospital grade receptacle. Electrical Specifications are described in Section (5.).
- H. The isolation label indicates that the BLANKETROL III and the blanket (applied part) are BF rated as a system. Contact with other parts (i.e. the quick-disconnect couplings) at the same time as contacting the patient will negate the type of BF rating.

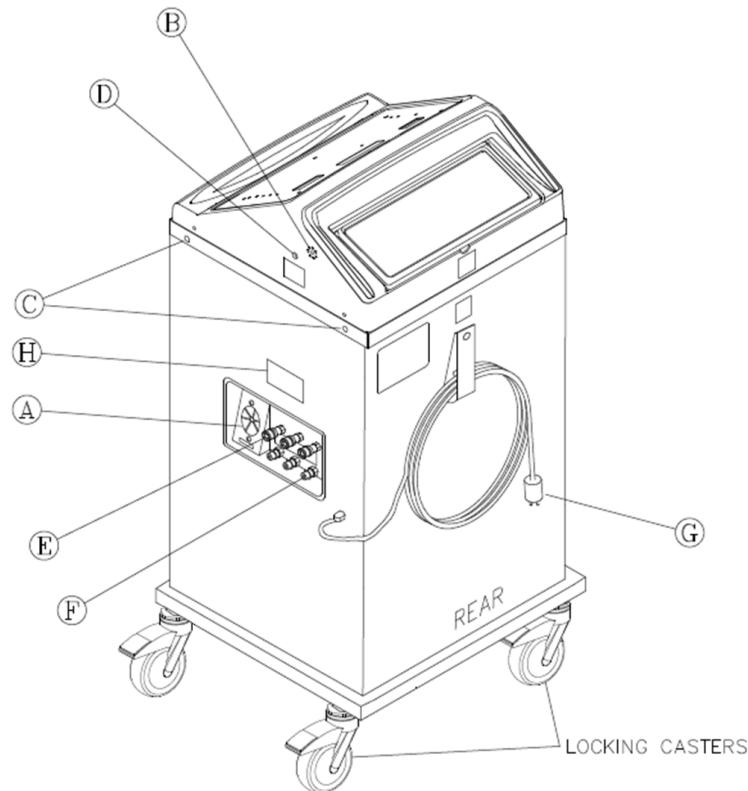

FIGURE 1-2. BLANKETROL III – RIGHT SIDE VIEW

1-2.3. External Features – Rear View

The external features in Figure (1-3.) of the BLANKETROL III unit are described as follows:

- A. The specification label outlines the BLANKETROL III unit's electrical requirements and displays the serial and model numbers of the unit.
- B. The air vents, on both the right and left side of the unit, provide air circulation for the microprocessor.
- C. The nylon strap is used to secure and store the coiled power cord when not in use.
- D. The rear enclosure panel secured with four screws provides access to the interior. The panel is removed to perform maintenance, repair, or replacement of components.
- E. The water fill opening is where the operator pours Sterile water or water that has been passed through a filter less than or equal to 0.22 microns into the unit to fill the reservoir.
- F. The operating instructions are printed directly on the back lid of the unit. This allows the operator to clearly see the directions and efficiently use the unit.
- G. The USB port for data reporting functions.

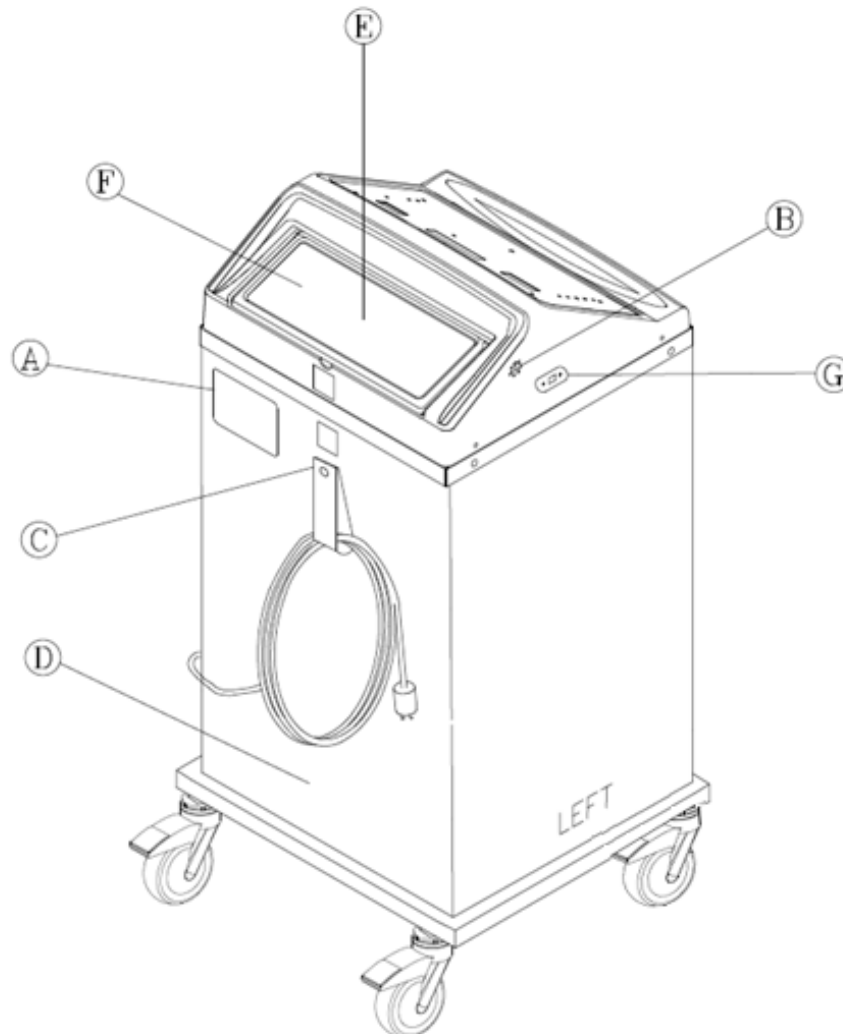

FIGURE 1-3. BLANKETROL III – REAR VIEW

1-2.4. Description of the BLANKETROL III Membrane Control Panel

The membrane control panel as shown in Figure (1-4.A.) for English and (1-4.B) for Symbols is composed of pressure sensitive touch switches and LED displays. The membrane control panel is divided into the following sections:

- A. The display labeled WATER shows the water temperature in the BLANKETROL III equipment.
- B. The MANUAL CONTROL button is used to activate the MANUAL CONTROL MODE. This mode's operation is based on the water temperature within the BLANKETROL III equipment relative to the desired Set Point temperature.
- C. The center display reports the status of the unit, displays the Set Point, and/or indicates changes the operator should make. It is referred to as the Status Display. The possible Status Displays are listed in Section (3-10.).
- D. The TEMP SET button and the Up and Down arrow buttons are used to adjust the Set Point as shown on the LCD display.
- E. The display labeled PATIENT shows the patient's temperature reading.
- F. The AUTO CONTROL button is used to activate the *AUTO CONTROL MODE*.
- G. The GRADIENT 10C button is used to activate the *GRADIENT 10C MODE*.
- H. The GRADIENT VARIABLE button is used to activate the unit *GRADIENT VARIABLE MODE*.
- I. The SMART button is used to activate the *SMART* function in the appropriate modes.
- J. The MONITOR ONLY button is used to monitor the patient's temperature without heating, cooling or circulating the water.
- K. The two switches labeled TEST INDICATORS and SILENCE ALARM are used to confirm that all the indicators on the membrane control panel are working and to silence the alarm in certain conditions.
- L. The POWER FAILURE symbol flashes the red LED to the left of the symbol and sounds an audible alarm when the unit loses power or when power has been interrupted, restored, and the unit does not resume previous operation.
- M. The LOW WATER symbol indicates the unit is low on water. The unit flashes the red LED to the left of the symbol, sounds an audible alarm, and displays "LOW WATER" in the Status Display. Refer to Section (3-12-D. Low Water).
- N. The C/F Button allows the operator to select the measurement scale, Celsius or Fahrenheit, by which the unit functions. This feature is only available on 115 Volt BLANKETROL III Systems.

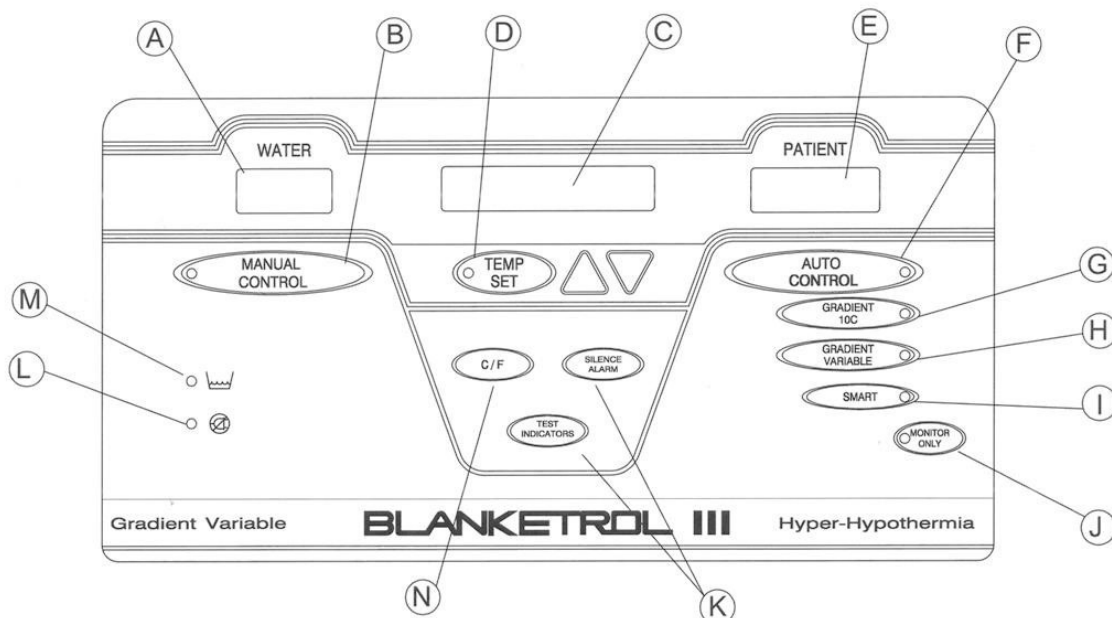

FIGURE 1-4.A. BLANKETROL III – MEMBRANE CONTROL PANEL (English)

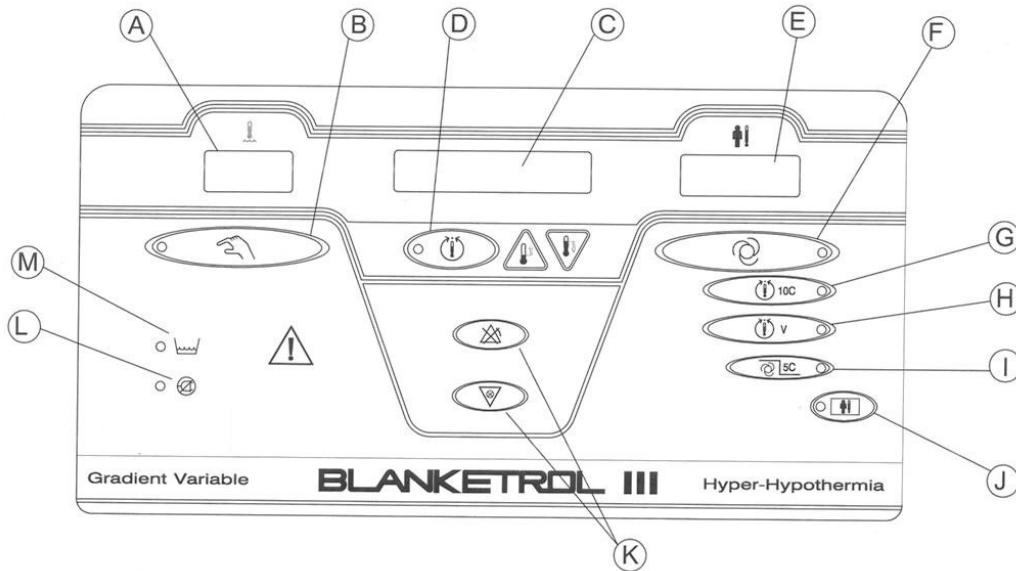

FIGURE 1-4.B. BLANKETROL III – MEMBRANE CONTROL PANEL (Symbols)

1-3. REQUIRED ACCESSORIES

Operation of the BLANKETROL III System requires the use of the blanket(s) designed to circulate warm or cool Sterile water or water that has been passed through a filter less than or equal to 0.22 microns, a connecting hose with quick-disconnect male and female couplings and, if any of the automatic modes are to be utilized, a 400 Series thermistor probe. Use only approved GENTHERM accessories including the Maxi-Therm®, Maxi-Therm Lite®, PlastiPad®, Gelli-Roll®, and Kool Kit® product families and the Head Wrap. See the Operation and Technical Manual for additional details.

1-4. USB PORT OPERATION

Refer to GENTHERM manual 57059 for instructions and usage of the BLANKETROL III Data Export Software.

CAUTION	
•	Do not make any connection to the USB port terminal while the device is also connected to a patient. Do not touch this connector and the patient at the same time. Patient injury may result.

WARNING	
•	The USB connection on the BLANKETROL III unit is intended for data transfer to a computer. Any other uses/connections may result in damage to the BLANKETROL III unit.

1-5. FUNCTIONAL DESCRIPTION OF THE BLANKETROL III SYSTEM

1-5.1. Theory of Operation

The Blanketrol III unit can be set so that it operates based on the water temperature (**MANUAL CONTROL**), or it can be set to operate based on the patient's temperature (**AUTOMATIC CONTROL**) using servo control. The three Automatic Modes include:

1. **AUTO CONTROL MODE**
2. **GRADIENT 10C SMART MODE**
3. **GRADIENT VARIABLE SMART MODE**

In **MANUAL MODE** the operator selects the circulating water temperature. The unit heats or cools the water to reach the selected temperature. The operator can change the Set Temperature (in this case the water temperature). This mode does not require a patient temperature probe. The patient temperature probe can be attached and used for close monitoring of the patient's temperature; however, it **will not** control or change the water temperature.

Note: The lowest water temperature is 4°C
The highest water temperature is 42°C

Patient temperature and skin integrity should be closely monitored. Exceeding 40°C for extended periods can cause tissue damage and burns. Clinical judgment should be used to determine the safe maximum contact periods based on patient age, clinical condition and current medications.

MANUAL MODE is recommended for:

- Pre-conditioning water to achieve desired water temperature before start of therapy
- Fever control in patients unable to have continuous core temperature monitoring
- Perioperative normothermia or warming of patients that don't require continuous core temperature monitoring.

Based on current recommendations, **MANUAL MODE** should be avoided for Targeted Temperature Management (TTM) and servo control (an Automatic Mode) should be used.

In **AUTO CONTROL MODE** the operator selects the desired **Patient Set Temperature** (based on physician's orders and/or hospital policy). For this function to operate, the patient must have a compatible 400 series temperature probe inserted for core temperature monitoring. The 400 series cable connects the probe to the Blanketrol III. The device operates by measuring the patient's temperature and comparing it to the selected Patient Set Temperature. Based on whether the patient's temperature is below or above the Set Temperature, the water temperature will adjust (heat or cool) to achieve the Patient Set Temperature— this is called servo control. The operator does **NOT** need to adjust the water temperature in this mode. When the patient's core temperature reaches the selected Patient Set Temperature, the device will cycle on and off to maintain this Patient Set Temperature. In **AUTO CONTROL MODE** when the device is cooling, the water may decrease down to 4°C if needed. Conversely, when the device is warming, the water may increase to 42°C if needed. This allows for a fast aggressive change in the patient's temperature.

Note: The lowest water temperature is 4°C
The highest water temperature is 42°C

Patient temperature and skin integrity should be closely monitored. Exceeding 40°C for extended periods can cause tissue damage and burns. Clinical judgment should be used to determine the safe maximum contact periods based on patient age, clinical condition and current medications.

AUTO CONTROL MODE is recommended for fast, aggressive temperature change for:

- Patients that can be treated for shivering
- Larger patients with denser body mass
- Patients going through withdrawal or that have increased metabolism
- Maintaining perioperative normothermia
- Targeted Temperature Management (TTM) (Current guidelines recommend servo control (Automatic Modes) for all TTM procedures)

SMART MODE should always be used with the GRADIENT MODES. It is a backup mode that can adjust the restrictions of the GRADIENT MODES when patients are warming or cooling in the wrong direction from intended

therapy/Patient Set Temperature. **SMART MODE** inhibits water temperature from following the patient temperature to maintain the GRADIENT restriction when it is in the wrong direction from intended therapy. SMART mode analyzes the Patient Set Temperature and the actual patient temperature every 30 minutes. If the patient is not at the selected Set Temperature, the software will open the GRADIENT offset up by 5, allowing the water temperature to vary an additional 5°C from the selected GRADIENT offset setting. This will occur every 30 minutes until the patient reaches the Set Temperature. When the patient achieves Set Temperature, the device will revert back to the original GRADIENT MODE setting and the water temperature will gradually change to reflect the original offset.

The Blanketrol III will not alarm or indicate when the patient's temperature is outside of the selected Patient Set Temperature. It is recommended to use an additional temperature monitoring system to set alarm parameters to alert the operator if the patient temperature falls outside of the acceptable range.

CAUTION: Do not use GRADIENT VARIABLE MODE or GRADIENT VARIABLE 10C MODE without SMART MODE. Unintended therapy could occur.

GRADIENT 10C SMART MODE is servo controlled just like the AUTO CONTROL MODE and operates similarly. The device monitors the patient's temperature and adjusts the water temperature to achieve/maintain the desired Patient Set Temperature. The difference in this mode is that the water temperature will only vary 10°C from the patient's actual measured temperature. These restrictions allow the device to gradually adjust the patient's temperature to the selected Patient Set Temperature and/or maintain tighter control of the patient's temperature to limit "overshoot" and temperature variations in larger patient. When the patient's core temperature reaches the selected Patient Set Temperature, the device will cycle on and off to maintain water temperature within 10°C of Patient Set Temperature.

Reminder: Patient temperature variations in surface cooling are normal and expected in the 0.5°C range. No variance at all could point to low metabolic activity.

Note: The lowest water temperature is 4°C
The highest water temperature is 42°C

Patient temperature and skin integrity should be closely monitored. Exceeding 40°C for extended periods can cause tissue damage and burns. Clinical judgment should be used to determine the safe maximum contact periods based on patient age, clinical condition and current medications.

GRADIENT 10C SMART MODE is recommended for gradual or controlled temperature change for:

- Neonates and small patients
- Patients who are overshooting their Set Temperature
- Patients with low metabolism or who are very sedated

GRADIENT VARIABLE SMART MODE is servo controlled just like AUTO CONTROL MODE and operates similarly to GRADIENT10C SMART MODE. The device monitors the patient's temperature and adjusts the water temperature to achieve/maintain the selected Patient Set Temperature. The difference in this mode is that the operator chooses the Variable offset (between 0°C and 33°C) between the patient's temperature and water temperature. **It is not recommended to use a setting of "0". This setting will only allow the water to track the actual patient temperature and therapy may not be adequately delivered to the patient.** The smaller **GRADIENT VARIABLE SMART MODE** settings of 1-4 may not sufficiently heat or cool the patient due to differences/fluctuations between the patient core temperature and skin surface temperature. These restrictions allow the device to gradually adjust the patient's temperature to the selected Patient Set Temperature and/or maintain tighter control of the patient's temperature to limit "overshoot" and temperature variations in larger patient. When the patient's core temperature reaches the selected Patient Set Temperature, the device will cycle on and off to maintain water temperature within a certain range (based on the selected offset VARIABLE) of Patient Set Temperature.

Reminder: Patient temperature variations in surface cooling are normal and expected in the 0.5°C range. No variance at all could point to low metabolic activity.

Note: The lowest water temperature is 4°C
The highest water temperature is 42°C

Patient temperature and skin integrity should be closely monitored. Exceeding 40°C for extended periods can cause tissue damage and burns. Clinical judgment should be used to determine the safe maximum contact periods based on patient age, clinical condition and current medications.

GRADIENT VARIABLE SMART MODE is recommended for gradual or controlled temperature change for:

- Neonates and small patients
- Patients who are overshooting their Set Temperature
- Patients with low metabolism or who are very sedated

The **TEMP SET** button is used to change all therapies and to pause the device by returning the circulating water back to the device from the blanket(s)/pad(s). The device may be paused to add more water, change out blankets or hoses, obtain radiology tests and/or stop therapy. To resume function of the device, the operator will push the **MANUAL** button, the **AUTO CONTROL** button, or the **10C GRADIENT** buttons.

If **GRADIENT VARIABLE SMART MODE** is being used and the caregiver needs to pause the therapy, press the **GRADIENT VARIABLE** button instead of the **TEMP SET** button. This will pause the therapy and return the circulating water back to the device from the blanket(s)/pad(s). When ready to re-start the device, press the **GRADIENT VARIABLE** button again and the original setting will remain. **However, if the GRADIENT VARIABLE button is being used and is subsequently paused by pushing the TEMP SET button, the VARIABLE offset will be cleared and reset back to 0.** To reprogram the **GRADIENT VARIABLE** offset, push the **GRADIENT VARIABLE** button to restart function.

SECTION 2. GENERAL PREPARATION OF THE BLANKETROL III SYSTEM

2-1. INTRODUCTION

This section describes the procedures to prepare the BLANKETROL III System for general use. This entails unpacking the shipment, arranging all the equipment for the first time, and completing a test routine. This section also outlines standard safety precautions and patient preparation/bedside care when using the hyper-hypothermia blanket(s). Technical support is available upon request.

2-2. UNPACKING THE SHIPMENT

See the Operation and Technical Manual for details.

2-3. FIRST TIME SET-UP/SYSTEM TEST ROUTINE

See the Operation and Technical Manual for details.

2-3.1. Inspecting and Arranging the Equipment

- A. Place the BLANKETROL III System in an uncluttered work space that is accessible to the correct power source with an ambient temperature between 15°C – 30°C (59°F – 86°F). Position the unit so that the membrane control panel faces the operator.
- B. Visually inspect the BLANKETROL III System to determine that there are no missing parts, unusual dents, or punctures.
- C. Examine the power cord for cuts or exposed wires and the power plug for bent or missing prongs.
- D. Review Section (1-2) to identify the features of the BLANKETROL III System.
- E. Collect and arrange the following equipment and supplies:
 - 1. Hyper-hypothermia blanket(s)
 - 2. Connecting hose with quick-disconnect fittings if using disposable blanket(s).
 - 3. 400 Series Thermistor Probes / connecting cables described in the Operation and Technical Manual.
- F. Lift the lid of the water fill opening and gradually pour approximately 2 gallons (7.6 liters) of Sterile water or water that has been passed through a filter less than or equal to 0.22 microns into the reservoir. Stop pouring when the water reaches the strainer visible at the bottom of the water fill opening.



- G. The BLANKETROL III and the blanket (applied part) are BF rated as a system. Contact with other parts (i.e. the quick-disconnect couplings) at the same time as contacting the patient will negate the type BF rating.
- H. Connect the blanket(s) to the unit by attaching the quick-disconnect female coupling of the connecting hose to a male outlet coupling (on the bottom row) of the unit. Attach the male quick-disconnect coupling of the connecting hose to a female return coupling (on the top row) of the unit. Each blanket must be connected to one outlet and one return.

To attach the couplings:

- 1. Grasp the female coupling of the connecting hose
- 2. Slide the collar back towards the hose
- 3. Push the female coupling over a male coupling of the unit
- 4. Allow the collar to SNAP into place and return to its original position
- 5. Gently pull on the connecting hose to assure a positive connection
- 6. Next, push back the collar of a female return hose on the unit with one hand
- 7. With the other hand, insert the male coupling of the connecting hose
- 8. Release the collar of the female return coupling
- 9. Push the male coupling until it SNAPS into position
- 10. Gently pull the connecting hose to assure a positive connection

- I. Check that the blanket is lying flat and that the connecting hose to the unit is not twisted or pinched.
- J. Check that the power switch of the unit is in "O" position (unit is off).
- K. Connect the plug to a properly grounded hospital grade receptacle.

2-3.2. Complete a System Test Routine

See the Operation and Technical Manual for details.

2-4. UNIT AND PATIENT RELATED PRECAUTIONS

This unit requires both water and electricity to operate.

Please consult the Warnings and Cautions section for a complete list of warnings and cautions related to the BLANKETROL III.

- A. Anytime the unit sounds an alarm, the operator should immediately check the Status Display and act accordingly, e.g., add water, remove from service, check the probe, etc.
 - B. The BLANKETROL III unit is equipped with a circuit breaker in the I/O (on/off) power switch to protect against current overload.
-

2-5. PATIENT PREPARATION AND BEDSIDE CARE

Effective use of the BLANKETROL III System must include proper patient care prior to and while using the hyper-hypothermia blanket(s).

A dry sheet should be placed between the hyper-hypothermia blanket and the patient when using PLASTIPAD[®], or MAXI-THERM[®] Blankets. The MAXI-THERM LITE[®] Blanket does not require an interposed sheet.

While using a hyper-hypothermia blanket include the following tasks:

- A. A physician's order is required for setting blanket temperature and use of equipment. At least every 20 minutes, or as directed by physician, check patient's temperature and skin integrity of areas in contact with blanket; also, check the BLANKETROL III's water temperature. Pediatric patients, temperature-sensitive patients with vascular disease, surgical patients, diabetics and patients with Raynaud's Disease are at greater risk for developing tissue injuries, and this should be considered when selecting the temperature, duration of therapy and frequency of skin checks. **Notify the physician promptly of any change in patient status in order to avoid serious injury or death.**
- B. The position and the placement of the 400 Series probe should be inspected regularly. Also, the BLANKETROL III System activates an alarm in the automatic modes when the patient probe registers outside the range of 30°C - 43.5°C (86°F - 110.3°F).
- C. Changes in skin color, edema, inflammation, or indications of pressure, especially over bony prominences, should be noted and treated promptly as ordered. Avoid prolonged tissue pressure and shearing forces over bony prominences.
- D. The patient should be turned and properly re-positioned according to hospital/institution policy/protocol.

SECTION 3. OPERATING THE BLANKETROL III SYSTEM

3-1. INTRODUCTION

This section describes how to operate the BLANKETROL III System in order to control a patient's temperature. First, collect the equipment and prepare the patient. Second, decide which mode of operation to use. Third, set the appropriate controls:

- AUTOMATIC CONTROL MODE,
- MANUAL CONTROL MODE,
- GRADIENT 10C SMART MODE,
- GRADIENT VARIABLE SMART MODE
- MONITOR ONLY MODE.

For proper knowledge and understanding of the unit, in-service is available upon request.

3-2. ARRANGING THE SYSTEM COMPONENTS

- A. Collect all supplies and equipment
1. BLANKETROL III unit
 2. Hyper-hypothermia blanket(s)
 3. Dry sheet or bath blanket
 4. Connecting hose (if blanket requires it)
 5. 400 Series probe
 6. Connecting cable (if using disposable probes)
 7. Sterile water or water that has been passed through a filter less than or equal to 0.22 microns

WARNING

- Due to electromagnetic compatibility, the BLANKETROL III unit should not be used adjacent to or stacked with other equipment. **Potential electromagnetic interference may result.** Other equipment includes ventilators, patient monitors, anesthesia delivery equipment, etc. Electromagnetic interference refers to electronic devices unintentionally affecting the operation of each other by emitting electromagnetic energy. Unit complies with IEC 60601-1-2.
- If the BLANKETROL III unit or the other equipment is not operating normally, remove the device from service and have a biomedical or service technician observe the device in operation. Refer to Section 5 for recommended separation distances between other equipment and the BLANKETROL III. **Failure to do so may result in damage to the BLANKETROL III system and patient injury.**

- B. Place the BLANKETROL III unit in the patient area, accessible to the correct power source, and in an ambient environment of 15°C – 30°C (59°F – 86°F).
- C. Review Section (1-2.) that outlines the features of the unit and membrane control panel.

CAUTION

- **Use Sterile water or water that has been passed through a filter less than or equal to 0.22 microns only. Do Not Use De-ionized water or Distilled water. De-ionized water may cause corrosion to plumbing system components. Do Not Use Tap Water. Minerals and deposits can clog plumbing system components.**
- **Do not use alcohol. Alcohol may cause blanket deterioration.**
- **Do not overfill. Overfilling may result in overflow when the water in the blanket drains back into the system when the system is turned off.**

- D. Check the level of Sterile water or water that has been passed through a filter less than or equal to 0.22 microns in the reservoir. To do so, lift the cover of the water fill opening and check if the water is visibly touching the strainer. If needed, carefully add Sterile water or water that has been passed through a filter less than or equal to 0.22 microns. In addition, if the water falls below a preset level, the alarm sounds and the Status Display flashes LOW WATER. The operator cannot proceed until this is corrected as described in Sections (3-12-D.) and (4-3.1).
- E. Check that the power switch is in the "O" position (unit is off).
- F. Inspect the power plug for bent or missing prongs.

WARNING

- **Do not by-pass ground lug (230V System). Electrical hazards may result.**

- G. Insert the plug into a properly grounded hospital grade receptacle.
- H. Lay the hyper-hypothermia blanket flat with the hose routed, without kinks, towards the unit.
- I. If the blanket is already filled, check that there are no leaks.

WARNING

- Any time water is found leaking into or around the unit, connecting hose, and/or blanket, turn the unit off, disconnect the power cord from its power source, and correct the problem before proceeding. Proper maintenance procedures should be followed including, but not limited to, the preventative maintenance described in this manual. Leaky blankets or hoses should never be used. **Water leaks could present a slip hazard and risk of infection and could lead to electric shock.**

- J. Cover the blanket with a dry sheet or bath blanket (if using PLASTIPAD[®], or MAXI-THERM[®] Blanket).
- K. Connect the blanket to the BLANKETROL III unit as described in Section (2-3.1.) Step (H).
- L. If a single-patient use hyper-hypothermia blanket is used, connect the color coded couplings of the connecting hose to the blanket as described in the instructions packaged with each blanket.
- M. Check that the blanket is flat and the connecting hose is not twisted or pinched.
- N. The hyper-hypothermia blanket may be pre-cooled or pre-warmed before positioning the patient. To do so, operate the system in *MANUAL CONTROL MODE* for a few minutes.
- O. Place the patient on the hyper-hypothermia blanket.

CAUTION

- Handling or use of the patient probe may result in damage from **electrostatic discharge (ESD)** if proper precautions are not taken.

- P. If the patient's temperature is to be monitored as required in an automatic control mode or *MONITOR ONLY MODE*, insert or attach one 400 Series probe in or on the patient.
1. A rectal probe is inserted into the rectum and secured with tape to the leg of the patient.
 2. The diaphragm of a skin probe is taped to the patient, usually under the patient's arm or on the chest.
 3. The esophageal probe is inserted in the patient. It is often preferred that the patient is comatose or under anesthesia when the probe is placed in the esophagus.

The 400 Series probe should be inspected periodically to insure that it is not dislodged or impacted. *The BLANKETROL III System sounds an alarm when the reading from the probe falls below 30°C (86°F).*

It is important that the 400 Series probe be inserted in or attached to the patient at least three minutes before pressing a control mode button. This will prevent the accidental triggering of the CHECK PROBE status message.
 4. The probe connecting cable is used to connect the BLANKETROL III System to disposable temperature probes.
- Q. If an upper hyper-hypothermia blanket is to be used, follow instructions in step (J).
- R. Connect the top blanket to the unit following the procedure described in Section (2-3.1.) Step (H).
- S. If no top hyper-hypothermia blanket is used, cover the patient with a top sheet. Patient preparation and bedside care are further described in Section (2-5.).
- T. Choose which operating mode to use: Operating in *AUTO CONTROL MODE* is described in Section (3-3.). Operating in *MANUAL CONTROL MODE* is described in Sections (3-4.) and (3-5.). Operating in *GRADIENT 10C SMART MODE* is described in section (3-6.). Operating in *GRADIENT VARIABLE SMART MODE* is described in Section (3-7.). Operating in *MONITOR ONLY MODE* is described in Section (3-8.).

NOTE: The maximum contact surface temperature is 41°C.

NOTE: If at any time, power is removed from the unit without actuating the power switch (I/O switch) a power fail alarm will activate and the Power fail symbol LED located on the membrane control panel will flash. To stop the alarm, restore power or push the SILENCE ALARM button.

In the case that the unit is powered-off for 5 seconds or less, the unit will resume the previous operation mode. However, if power is off longer than 5 seconds, the unit will go into power fail alarm mode.

3-3. OPERATING THE BLANKETROL III SYSTEM IN AUTO CONTROL MODE

WARNING	
●	A physician's order is required for setting blanket temperature and use of equipment. At least every 20 minutes, or as directed by physician, check patient's temperature and skin integrity of areas in contact with blanket; also, check the BLANKETROL III's water temperature. Pediatric patients, temperature-sensitive patients with vascular disease, surgical patients, diabetics and patients with Raynaud's Disease are at greater risk for developing tissue injuries, and this should be considered when selecting the temperature, duration of therapy and frequency of skin checks. Notify the physician promptly of any change in patient status in order to avoid serious injury or death.
●	The method of temperature control provided by all hyper-hypothermia units presents the danger of heating or cooling body tissues, particularly the skin, to a point where they are injured, i.e., burns or frostbite, respectively. The clinician is responsible for determining the appropriateness of the temperature limits in dependency to time. Exceeding 40°C water temperature for extended periods can cause tissue damage and burns. Clinical judgment should be used to determine the safe maximum contact periods based on patient age, clinical condition, and current medications. Depending on the extent and severity of a burn, very serious and even fatal complications may arise.
●	Due to static electricity, a 400 Series Probe may not be connected to the BLANKETROL III unit without first discharging one's body to the frame of the BLANKETROL III unit or another grounded object. Failure to do so may result in damage from electrostatic discharge (ESD). All staff that may touch the 400 Series Probe must be familiar with this warning and basic static electricity or electrostatic discharge (ESD) training.
●	Basic static electricity or ESD training should include an introduction to the physics of electrostatic charge, the voltage levels that can occur in normal practice and the damage that can be done to electronic components if equipment is touched by an operator who is electrostatically charged. Further, an explanation should be given of methods to prevent build-up of electrostatic charge, and how and why to discharge one's body to the BLANKETROL III unit or another grounded object. Failure to do so may result in damage from electrostatic discharge (ESD).

CAUTION	
●	If device is set to operate in any Automatic mode, the device will shut down and activate the CHECK PROBE alarm if the patient temperature falls below 30.0°C (86°F). Patient temperature must rise above 30.0°C (86°F) before restarting the device in Automatic mode. The device can be operated in Manual Control mode in order to warm the patient above 30.0°C (86°F). Potential for interruption of therapy.
●	Do not use GRADIENT VARIABLE MODE OR Gradient 10C MODE without SMART MODE. Unintended therapy could occur.

In AUTO CONTROL MODE, the BLANKETROL III System can monitor the patient's temperature and deliver the maximum heating or cooling therapy in order to bring the patient's temperature to a Set Point chosen by the operator.

After arranging the equipment as described in Section (3-2.), proceed as follows:

- A. Check the placement of the 400 Series probe in or on the patient.
- B. Connect the 400 Series probe to the 1/4 inch receptacle on the right side of the unit. If using a disposable probe, a connecting cable is needed to connect the probe to the BLANKETROL III.
- C. Press the power switch to the "I" position.
 1. The switch illuminates green.
 2. The microprocessor board goes through self-test.
 3. The Status Display flashes CHECK SETPT.
- D. Consult the physician's orders to determine the desired patient Set Point temperature. As a safety precaution, the SET POINT display can only be set between 30°C - 40°C (86°F - 104°F) to operate in *AUTOMATIC CONTROL MODE*.
- E. Use the C/F button to choose the desired temperature scale (English membrane only).
- F. Press the TEMP SET button.

1. The microprocessor board beeps.
 2. The LED in the corner of the button illuminates.
 3. The SET POINT display shows a temperature reading.
 4. The Status Display shows SET TEMP.
- G. Press the Up arrow or Down arrow to change the SET POINT display to the desired patient temperature. The display can only be set between 30°C -40°C (86°F - 104°F) or else the system will not operate in *AUTOMATIC CONTROL MODE*.
1. The microprocessor board beeps.
 2. The Set Point on the Status Display changes.
- H. Press the AUTO CONTROL button.
1. The microprocessor board beeps.
 2. The LED in the corner of the button illuminates.
 3. The Patient display shows the patient's actual temperature.
 4. The WATER display shows the actual temperature of the water in the BLANKETROL III equipment.
 5. The Status Display indicates:
 * XXXXXX PATIENT
 AUTO SETPT 37.0 C
 Or Status Display shows:
 PATIENT @SETPT
 AUTO SETPT 37.0 C
 * ("XXXXXX" represents "HEATING" or "COOLING".)
 The above depends upon the relationship of the patient temperature to the Set Point temperature. Note that the Set Point may be displayed in Fahrenheit.
 6. The pump is activated. The heater or compressor may also be activated.
 7. The water flow indicator on the right side panel begins to move.
 8. The water moves from the unit to the blanket and returns to the unit.
- I. Check the water flow indicator to confirm that the water is circulating.
- J. Touch the hyper-hypothermia blanket to confirm that the blanket is heating/cooling.
- K. To make any changes in the control settings, press the TEMP SET button and begin again.

The BLANKETROL III System is now operating in *AUTOMATIC CONTROL MODE*. You should continue to monitor the system and the patient. (Review the suggestions for patient care described in Section (2-5)).

If at any time the Status Display shows a message other than the messages described in *AUTOMATIC CONTROL MODE* procedures, make the changes indicated by the display and/or consult the list of display messages in Section (3-10.). If at any time the unit sounds an alarm and the Status Display flashes a message, make the changes indicated. To turn off the unit or discontinue hyper-hypothermia treatment, proceed as described in Section (3-9.).

NOTE: IN ORDER TO CHANGE FROM ANY CONTROL MODE TO ANOTHER CONTROL MODE, FIRST PRESS THE "TEMP SET" BUTTON, AND THEN SELECT THE OPERATING MODE OF CHOICE.

In order to change from *AUTOMATIC CONTROL MODE* to *MONITOR ONLY MODE*, press the MONITOR ONLY button.

3-4. OPERATING THE BLANKETROL III SYSTEM IN MANUAL CONTROL MODE

WARNING	
●	A physician's order is required for setting blanket temperature and use of equipment. At least every 20 minutes, or as directed by physician, check patient's temperature and skin integrity of areas in contact with blanket; also, check the BLANKETROL III's water temperature. Pediatric patients, temperature-sensitive patients with vascular disease, surgical patients, diabetics and patients with Raynaud's Disease are at greater risk for developing tissue injuries, and this should be considered when selecting the temperature, duration of therapy and frequency of skin checks. Notify the physician promptly of any change in patient status in order to avoid serious injury or death.
●	The method of temperature control provided by all hyper-hypothermia units presents the danger of heating or cooling body tissues, particularly the skin, to a point where they are injured, i.e., burns or frostbite, respectively. The clinician is responsible for determining the appropriateness of the temperature limits in dependency to time. Exceeding 40°C water temperature for extended periods can cause tissue damage and burns. Clinical judgment should be used to determine the safe maximum contact periods based on patient age, clinical condition, and current medications. Depending on the extent and severity of a burn, very serious and even fatal complications may arise.

The BLANKETROL III System can be set so that it operates based upon the actual temperature of the water in the BLANKETROL III equipment relative to the Set Point temperature.

In *MANUAL CONTROL MODE* the BLANKETROL III System does not read the patient's temperature, so the unit will not adjust the water temperature in the BLANKETROL III equipment accordingly. Because of this, special care must be taken to monitor the patient's temperature. And, as in all cases, the patient's skin integrity must be closely monitored

After arranging the equipment as described in Section (3-2.), proceed as follows:

- A. Press the power switch to the "I" position.
 1. The switch illuminates green.
 2. The microprocessor board goes through self-test.
 3. The Status Display flashes CHECK SETPT.
- B. Consult the physician's orders to determine the desired patient Set Point temperature and the desired water temperature setting.
- C. Press the TEMP SET Switch.
 1. The microprocessor board beeps.
 2. The LED in the corner of the button illuminates.
 3. The SET POINT display shows a temperature reading.
 4. The Status Display shows SET TEMP.
- D. Use the C/F button to choose the desired temperature scale (English membrane only).
- E. Press the Up arrow or Down arrow to change the SETPOINT display to the desired water Set Point temperature. As a safety precaution, the water temperature in the BLANKETROL III equipment can only be set between 4°C - 42°C (39.2°F - 107.6°F).
 1. The microprocessor board beeps.
 2. The Status Display changes.
- F. Press the MANUAL CONTROL switch.
 1. The microprocessor board beeps.
 2. The LED in the corner of the button illuminates.
 3. The BLANKET/WATER display shows the actual temperature of the water in the BLANKETROL III equipment.
 4. The Status Display shows:

```
*XXXXXX WATER
          MANUAL   SETPT 37.0 C
```

 Or Status Display shows:

```
WATER @SETPT
          MANUAL   SETPT 37.0 C
```

* ("XXXXXX" represents "HEATING" or "COOLING".)

The above depends upon the relationship of the blanket water temperature to the Set Point temperature. Note that the Set Point may be displayed in Fahrenheit.

5. The pump is activated. The heater or compressor may be activated.
 6. The Water Flow indicator on the right side panel begins to move.
 7. The water moves from the unit through the blanket and returns to the unit.
- G. Check the water flow indicator to confirm that the water is circulating.
- H. Touch the hyper-hypothermia blanket to confirm that the blanket is heating/cooling.
- I. To make any changes in the control setting, press the TEMP SET button and begin again.

The BLANKETROL III System is now operating in *MANUAL CONTROL MODE*. The operator must continue to monitor the change in the patient's temperature. (Review the suggestions for patient care described in Section (2-5).)

If at any time the Status Display shows a message other than the messages described in *MANUAL CONTROL MODE* procedures, make the changes indicated by the display and/or consult the list of display messages in Section (3-10.). If at any time the unit sounds an alarm and the Status Display flashes a message, make the changes as indicated.

To turn off the unit or discontinue hyper-hypothermia treatment, proceed as described in Section (3-9.).

NOTE: IN ORDER TO CHANGE FROM *MANUAL CONTROL MODE* TO ANOTHER CONTROL MODE, FIRST PRESS THE "TEMP SET" BUTTON, AND THEN SELECT THE OPERATING MODE OF CHOICE.

In order to change from *MANUAL CONTROL MODE* to *MONITOR ONLY MODE*, simply press the MONITOR ONLY button.

3-5. OPERATING THE BLANKETROL III SYSTEM IN *MANUAL CONTROL MODE* WITH THE ADDITION OF THE PATIENT PROBE

WARNING	
●	A physician's order is required for setting blanket temperature and use of equipment. At least every 20 minutes, or as directed by physician, check patient's temperature and skin integrity of areas in contact with blanket; also, check the BLANKETROL III's water temperature. Pediatric patients, temperature-sensitive patients with vascular disease, surgical patients, diabetics and patients with Raynaud's Disease are at greater risk for developing tissue injuries, and this should be considered when selecting the temperature, duration of therapy and frequency of skin checks. Notify the physician promptly of any change in patient status in order to avoid serious injury or death.
●	The method of temperature control provided by all hyper-hypothermia units presents the danger of heating or cooling body tissues, particularly the skin, to a point where they are injured, i.e., burns or frostbite, respectively. The clinician is responsible for determining the appropriateness of the temperature limits in dependency to time. Exceeding 40°C water temperature for extended periods can cause tissue damage and burns. Clinical judgment should be used to determine the safe maximum contact periods based on patient age, clinical condition, and current medications. Depending on the extent and severity of a burn, very serious and even fatal complications may arise.
●	Due to static electricity, a 400 Series Probe may not be connected to the BLANKETROL III unit without first discharging one's body to the frame of the BLANKETROL III unit or another grounded object. Failure to do so may result in damage from electrostatic discharge (ESD). All staff that may touch the 400 Series Probe must be familiar with this warning and basic static electricity or electrostatic discharge (ESD) training.
●	Basic static electricity or ESD training should include an introduction to the physics of electrostatic charge, the voltage levels that can occur in normal practice and the damage that can be done to electronic components if equipment is touched by an operator who is electrostatically charged. Further, an explanation should be given of methods to prevent build-up of electrostatic charge, and how and why to discharge one's body to the BLANKETROL III unit or another grounded object. Failure to do so may result in damage from electrostatic discharge (ESD).

When the BLANKETROL III System is set to operate in *MANUAL CONTROL MODE*, the patient probe can be connected to the unit to monitor the patient's temperature without affecting the operation. The system continues to operate based upon the temperature of the water in the BLANKETROL III equipment relative to the desired Blanket/Water temperature.

After arranging the equipment as described in Section (3-2.), proceed as follows:

- A. Check the placement of the 400 Series probe in or on the patient.
- B. Connect the 400 Series probe to the 1/4 inch receptacle on the right side of the unit.

- C. Follow Steps (A - I) as described in Section (3-4.). In addition to the Blanket/Water display showing actual water temperature, the Patient display shows the actual patient temperature.

The BLANKETROL III System is now operating in *MANUAL CONTROL MODE* while monitoring the patient's temperature. However, you must also monitor the patient's temperature. (Review the suggestions for patient care described in Section (2-5.).

If at any time the Status Display shows a message other than the messages described in *MANUAL CONTROL MODE* procedures, make the changes indicated by the display and/or consult the list of display messages in Section (3-10.). If at any time the unit sounds an alarm and the Status Display flashes a message, make the changes as indicated.

To turn off the unit or discontinue hyper-hypothermia treatment, proceed as described in Section (3-9.).

NOTE: IN ORDER TO CHANGE FROM *MANUAL CONTROL MODE* TO ANOTHER CONTROL MODE, FIRST PRESS THE "TEMP SET" BUTTON, AND THEN SELECT THE OPERATING MODE OF CHOICE.

In order to change from *MANUAL CONTROL MODE* to *MONITOR ONLY MODE*, simply press the Monitor Only button.

3-6. OPERATING THE BLANKETROL III UNIT IN *GRADIENT 10C SMART MODE*

WARNING	
•	A physician's order is required for setting blanket temperature and use of equipment. At least every 20 minutes, or as directed by physician, check patient's temperature and skin integrity of areas in contact with blanket; also, check the BLANKETROL III's water temperature. Pediatric patients, temperature-sensitive patients with vascular disease, surgical patients, diabetics and patients with Raynaud's Disease are at greater risk for developing tissue injuries, and this should be considered when selecting the temperature, duration of therapy and frequency of skin checks. Notify the physician promptly of any change in patient status in order to avoid serious injury or death.
•	The method of temperature control provided by all hyper-hypothermia units presents the danger of heating or cooling body tissues, particularly the skin, to a point where they are injured, i.e., burns or frostbite, respectively. The clinician is responsible for determining the appropriateness of the temperature limits in dependency to time. Exceeding 40°C water temperature for extended periods can cause tissue damage and burns. Clinical judgment should be used to determine the safe maximum contact periods based on patient age, clinical condition, and current medications. Depending on the extent and severity of a burn, very serious and even fatal complications may arise.
•	Due to static electricity, a 400 Series Probe may not be connected to the BLANKETROL III unit without first discharging one's body to the frame of the BLANKETROL III unit or another grounded object. Failure to do so may result in damage from electrostatic discharge (ESD). All staff that may touch the 400 Series Probe must be familiar with this warning and basic static electricity or electrostatic discharge (ESD) training.
•	Basic static electricity or ESD training should include an introduction to the physics of electrostatic charge, the voltage levels that can occur in normal practice and the damage that can be done to electronic components if equipment is touched by an operator who is electrostatically charged. Further, an explanation should be given of methods to prevent build-up of electrostatic charge, and how and why to discharge one's body to the BLANKETROL III unit or another grounded object. Failure to do so may result in damage from electrostatic discharge (ESD).

CAUTION	
•	If device is set to operate in any Automatic mode, the device will shut down and activate the CHECK PROBE alarm if the patient temperature falls below 30.0°C (86°F). Patient temperature must rise above 30.0°C (86°F) before restarting the device in Automatic mode. The device can be operated in Manual Control mode in order to warm the patient above 30.0°C (86°F). Potential for interruption of therapy.
•	Do not use GRADIENT VARIABLE MODE OR Gradient 10C MODE without SMART MODE. Unintended therapy could occur.

The BLANKETROL III System can be set to gradually change a patient's temperature by maintaining the water in the BLANKETROL III equipment at a maximum temperature 10°C (18°F) different from the patient's body temperature and then increasing the gradient offset (temperature difference) between the patient's temperature and the water temperature by 5°C (9°F) every 30 minutes.

After arranging the equipment as described in Section (3-2.), proceed as follows:

- A. Check the placement of the 400 Series probe in or on the patient.
- B. Connect the probe to the 1/4 inch receptacle on the right side of the unit.
- C. Press the power switch to "I" position.
1. The switch illuminates green.
 2. The microprocessor board goes through self-test.

3. The Status Display flashes CHECK SETPT.
- D. Consult the physician's orders to determine the desired patient Set Point temperature. As a safety precaution, the desired patient Set Point can only be set between 30°C - 40°C (86°F - 104°F) to operate in *GRADIENT 10C SMART MODE*.
- E. Use the C/F button to choose the desired temperature scale (English membrane only).
- F. Press the TEMP SET button.
1. The microprocessor board beeps.
 2. The LED in the corner of the button illuminates.
 3. The Status Display shows a temperature Set Point.
- G. Press the Up arrow or Down arrow to change the Set Point temperature on the Status Display to the desired patient temperature. The display can only be set between 30°C - 40°C (86°F - 104°F).
1. The microprocessor board beeps.
 2. The Set Point temperature in the Status Display changes.
- H. Press the GRADIENT 10C button.
1. The microprocessor board beeps.
 2. The LED in the corner of the button illuminates.
 3. The PATIENT display shows the patient's actual temperature.
 4. The WATER display shows the actual temperature of the water in the BLANKETROL III equipment.
 5. The Status Display shows:
 * XXXXXX PATIENT
 AUTO SETPT 37.0 C
 Or Status Display shows:
 PATIENT @SETPT
 AUTO SETPT 37.0 C

 * ("XXXXXX" represents "HEATING" or "COOLING".)
 The above depends upon the relationship of the patient temperature to the Set Point temperature. Note that the Set Point may be displayed in Fahrenheit.
 6. The pump is activated. The heater or compressor may also be activated.
 7. The water flow indicator on the right side panel begins to move.
 8. The water moves from the unit to the blanket and returns to the unit.
- I. Press the SMART key.
1. The microprocessor board beeps.
 2. The LED on the SMART button illuminates.
- J. Check the Water Flow indicator to confirm that the water is circulating.
- K. Touch the hyper-hypothermia blanket to confirm that the blanket is heating/cooling.
- L. To make any changes in the control settings, press the TEMP SET button and begin again.

The BLANKETROL III System is now operating in *GRADIENT 10C SMART MODE*. You should continue to monitor the system and the patient. (Review the suggestions for patient care described in Section (2-5)).

If at any time the Status Display shows a message other than the messages described in *GRADIENT 10C SMART MODE* procedures, make the changes indicated by the display and/or consult the list of display messages in Section (3-10.). If at any time the unit sounds an alarm and the Status Display flashes a message, make the changes indicated. To turn off the unit or discontinue hyper-hypothermia treatment, proceed as described in Section (3-9.).

NOTE: IN ORDER TO CHANGE FROM GRADIENT 10C SMART MODE TO ANOTHER CONTROL MODE, FIRST PRESS THE "TEMP SET" BUTTON, AND THEN SELECT THE OPERATING MODE OF CHOICE.

In order to change from *GRADIENT 10C SMART MODE* to *MONITOR ONLY MODE*, simply press the MONITOR ONLY button.

3-7. OPERATING THE BLANKETROL III SYSTEM IN GRADIENT VARIABLE SMART MODE

WARNING	
●	A physician's order is required for setting blanket temperature and use of equipment. At least every 20 minutes, or as directed by physician, check patient's temperature and skin integrity of areas in contact with blanket; also, check the BLANKETROL III's water temperature. Pediatric patients, temperature-sensitive patients with vascular disease, surgical patients, diabetics and patients with Raynaud's Disease are at greater risk for developing tissue injuries, and this should be considered when selecting the temperature, duration of therapy and frequency of skin checks. Notify the physician promptly of any change in patient status in order to avoid serious injury or death.
●	The method of temperature control provided by all hyper-hypothermia units presents the danger of heating or cooling body tissues, particularly the skin, to a point where they are injured, i.e., burns or frostbite, respectively. The clinician is responsible for determining the appropriateness of the temperature limits in dependency to time. Exceeding 40°C water temperature for extended periods can cause tissue damage and burns. Clinical judgment should be used to determine the safe maximum contact periods based on patient age, clinical condition, and current medications. Depending on the extent and severity of a burn, very serious and even fatal complications may arise.
●	Due to static electricity, a 400 Series Probe may not be connected to the BLANKETROL III unit without first discharging one's body to the frame of the BLANKETROL III unit or another grounded object. Failure to do so may result in damage from electrostatic discharge (ESD). All staff that may touch the 400 Series Probe must be familiar with this warning and basic static electricity or electrostatic discharge (ESD) training.
●	Basic static electricity or ESD training should include an introduction to the physics of electrostatic charge, the voltage levels that can occur in normal practice and the damage that can be done to electronic components if equipment is touched by an operator who is electrostatically charged. Further, an explanation should be given of methods to prevent build-up of electrostatic charge, and how and why to discharge one's body to the BLANKETROL III unit or another grounded object. Failure to do so may result in damage from electrostatic discharge (ESD).
CAUTION	
●	If device is set to operate in any Automatic mode, the device will shut down and activate the CHECK PROBE alarm if the patient temperature falls below 30.0°C (86°F). Patient temperature must rise above 30.0°C (86°F) before restarting the device in Automatic mode. The device can be operated in Manual Control mode in order to warm the patient above 30.0°C (86°F). Potential for interruption of therapy.
●	Do not use GRADIENT VARIABLE MODE OR Gradient 10C MODE without SMART MODE. Unintended therapy could occur.

The BLANKETROL III System can be set to gradually change the patient's temperature according to *specific patient's needs* by maintaining the water in the BLANKETROL III equipment at a specified temperature from the patient's body temperature (as chosen by the operator). The system then increases this temperature difference by 5°C (9°F) every 30 minutes until the patient's temperature reaches Set Point.

After arranging the equipment as described in Section (3-2.), proceed as follows:

- A. Check the placement of the 400 Series probe in or on the patient.
- B. Connect the probe to the 1/4 inch receptacle on the right side of the unit.
- C. Press the power switch to the "I" position.
 1. The switch illuminates green.
 2. The microprocessor board goes through self-test.
 3. The Status Display flashes CHECK SETPT.
- D. Consult the physician's orders to determine the desired patient Set Point temperature. As a safety precaution, the desired patient Set Point can only be set between 30°C - 40°C (86°F - 104°F) to operate in *GRADIENT VARIABLE SMART MODE*.
- E. Use the C/F button to choose the desired temperature scale (English membrane only)
- F. Press the TEMP SET button.
 1. The microprocessor board beeps.
 2. The LED in the corner of the switch illuminates.
 3. The Status Display shows a temperature Set Point.

- G. Press the Up arrow or Down arrow to change the Set Point temperature on the Status Display to the desired patient temperature. The display can only be set between 30°C -40°C (86°F - 104°F).
1. The microprocessor board beeps.
 2. The Set Point temperature in the Status Display changes.
- H. Press the GRADIENT VARIABLE button.
1. The microprocessor board beeps.
 2. The LED in the corner of the button illuminates.
 3. The Status Display shows a gradient variable.
- I. Press the Up arrow or Down arrow to change the gradient variable offset to the desired value.
1. The microprocessor board beeps.
 2. The Set Point temperature in the Status Display changes.
- J. Press the GRADIENT VARIABLE button.
1. The microprocessor board beeps.
 2. The LED in the corner of the switch illuminates.
 3. The PATIENT display shows the patient's actual temperature.
 4. The WATER display shows the actual temperature of the water in the BLANKETROL III equipment.
 5. The Status Display shows:
 *XXXXXX PATIENT
 AUTO SETPT 37.0 C
 Or Status Display shows:
 PATIENT @SETPT
 AUTO SETPT 37.0 C
 * ("XXXXXX" represents "HEATING" or "COOLING".)
 The above depends upon the relationship of the patient temperature to the Set Point temperature. Note that the Set Point may be displayed in Fahrenheit.
 6. The pump is activated. The heater or compressor may also be activated.
 7. The Water Flow indicator on the right side panel begins to move.
 8. The water moves from the unit to the blanket and returns to the unit.
- K. Press the SMART key.
1. The microprocessor board beeps.
 2. The LED on the SMART button illuminates.
- L. Check the water flow indicator to confirm that the water is circulating.
- M. Touch the hyper-hypothermia blanket to confirm that the blanket is heating/cooling.
- N. To make any changes in the control settings, press the TEMP SET button and begin again.

The BLANKETROL III System is now operating in *GRADIENT VARIABLE SMART MODE*. You should continue to monitor the system and the patient. (Review the suggestions for patient care described in Section (2-5).)

If at any time the Status Display shows a message other than the messages described in *GRADIENT VARIABLE SMART MODE* procedures, make the changes indicated by the display and/or consult the list of display messages in Section (3-10.). If at any time the unit sounds an alarm and the Status Display flashes a message, make the changes indicated. To turn off the unit or discontinue hyper-hypothermia treatment, proceed as described in Section (3-9.).

NOTE: IN ORDER TO CHANGE FROM GRADIENT VARIABLE SMART MODE TO ANOTHER CONTROL MODE, FIRST PRESS THE "TEMP SET" BUTTON, AND THEN SELECT THE OPERATING MODE OF CHOICE.

In order to change from *GRADIENT VARIABLE SMART MODE* to *MONITOR ONLY MODE*, simply press the MONITOR ONLY button.

3-8. OPERATING THE BLANKETROL III SYSTEM IN *MONITOR ONLY MODE*

WARNING	
●	Due to static electricity, a 400 Series Probe may not be connected to the BLANKETROL III unit without first discharging one's body to the frame of the BLANKETROL III unit or another grounded object. Failure to do so may result in damage from electrostatic discharge (ESD). All staff that may touch the 400 Series Probe must be familiar with this warning and basic static electricity or electrostatic discharge (ESD) training.
●	Basic static electricity or ESD training should include an introduction to the physics of electrostatic charge, the voltage levels that can occur in normal practice and the damage that can be done to electronic components if equipment is touched by an operator who is electrostatically charged. Further, an explanation should be given of methods to prevent build-up of electrostatic charge, and how and why to discharge one's body to the BLANKETROL III unit or another grounded object. Failure to do so may result in damage from electrostatic discharge (ESD).

The BLANKETROL III System can be set so it displays the patient's temperature but does not heat, cool, or circulate the water. In this operating mode the patient may or may not already be positioned on a hyper-hypothermia blanket, but the unit and the 400 Series probe must be arranged as described in Section (3-2.).

After arranging the equipment, proceed as follows:

- A. Check the placement of the 400 Series probe in or on the patient.
- B. Connect the probe to the 1/4 inch receptacle on the right side of the unit.
- C. Press the power switch to "I" position.
 1. The switch illuminates green.
 2. The microprocessor board goes through self-test.
 3. The Status Display flashes CHECK SETPT.
- D. Press the MONITOR ONLY button.
 1. The microprocessor board beeps.
 2. The LED in the corner of the button illuminates.
 3. The Patient display shows the patient's temperature.
 4. The Status Display indicates MONITOR ONLY and the selected temperature scale.
- E. To make any changes in the control settings, press the TEMP SET button and begin again.

The BLANKETROL III System is now operating in *MONITOR ONLY MODE*.

If at any time the Status Display shows a message other than the messages described in *MONITOR ONLY MODE* procedures, make the changes indicated by the display and/or consult the list of display messages in Section (3-10.). If at any time the unit sounds an alarm and the Status Display flashes a message, make the changes indicated. To turn off the unit or discontinue hyper-hypothermia treatment, proceed as described in Section (3-9.).

NOTE: IN ORDER TO CHANGE FROM *MONITOR ONLY MODE* TO ANOTHER OPERATING MODE, FIRST PRESS THE "TEMP SET" BUTTON, AND THEN SELECT THE OPERATING MODE OF CHOICE.

3-9. CONCLUDING HYPER-HYPOTHERMIA TREATMENT

Discontinue therapy upon the order of the physician. Patient's temperature can drift up or down .5°C (1°F) after therapy has been discontinued. The drift may be greater if the patient has been shivering and treatment is abruptly discontinued. The operator should continue to monitor the patient's temperature. To do so, the operator may choose to operate the system in *MONITOR ONLY MODE* as described in section 3-8.

To change the mode of operation or to stop the unit, the operator must press the TEMP SET button or turn the power switch to the "O" position. The operator can go directly to *MONITOR ONLY MODE* from any of the control modes by pressing the MONITOR ONLY button.

When the hyper-hypothermia therapy is concluded and the unit is turned off:

- A. Permit the blanket(s) and hose to remain connected to the unit for about ten minutes. This allows some of the water to drain back into the unit.
- B. Remove the probe from the patient and 1/4 inch receptacle. Maintenance of the REUSABLE probe is described in section 4-5.

- C. Disconnect the power cord from the power source, loosely coil it and attach it to the back panel using the nylon strap.
- D. Disconnect the connecting hose from the unit and store in the front storage drawer.
- E. Remove the blanket(s).
- F. For reusable PLASTIPAD® blankets, loosely coil the hose lengthwise in the center of the blanket. Fold the blanket lengthwise into the center, 1/3 from the left side and 1/3 from the right side. Maintenance of the blanket is described in the *Operation and Technical Manual*.

For Single-Patient Use blankets, dispose of the blanket per hospital/institution policy/protocol.

3-10. STATUS DISPLAY MESSAGES

The Status Display located in the center of the BLANKETROL III unit membrane control panel reports the operating status of the unit or indicates changes the operator must make. The Status Display can show different messages to guide the operator. The following list defines each message and describes the changes, if any, the operator must make. Note that in the list below, the symbol “x” is used to indicate a numerical digit that can change based on measurements or operator actions and “Y” is used when C or F would be displayed depending on the temperature scale in use.

A. During normal operation in *MANUAL CONTROL MODE*, the Status Display shows the following messages:

Status Display Message	Function
MANUAL	This message is displayed on the left side of the bottom line and indicates that the BLANKETROL III is operating in <i>MANUAL CONTROL MODE</i> .
SETPT xxx.xY *	* (“xxx.x” represents Temperature and “Y” represents Centigrade or Fahrenheit.) This message is displayed on the right side of the bottom line and indicates the desired/current Set Point temperature for the water in the BLANKETROL III equipment with appropriate temperature scale.
HEATING WATER	This message is displayed on the top line when the BLANKETROL III is heating the circulating water.
COOLING WATER	This message is displayed on the top line when the BLANKETROL III is cooling the circulating water.
WATER @SETPT	This message is displayed on the top line when the water temperature has reached the water temperature Set Point.

B. During normal operation in the three automatic modes, *AUTOMATIC CONTROL MODE*, , *GRADIENT 10C SMART MODE*, , and *GRADIENT VARIABLE SMART MODE*, the Status Display shows the following messages:

Status Display Message	Function
AUTO	This message is displayed on the left side of the bottom line and indicates that the BLANKETROL III is operating in one of the three automatic modes.
SETPT xxx.xY *	* (“xxx.x” represents Temperature and “Y” represents Centigrade or Fahrenheit.) This message is displayed on the right side of the bottom line in the three automatic modes and indicates the desired/current Set Point temperature for the patient with appropriate temperature scale.
HEATING PATIENT	This message is displayed on the top line when the BLANKETROL III is heating the patient.
COOLING PATIENT	This message is displayed on the top line when the BLANKETROL III is cooling the patient.
PATIENT @SETPT	This message is displayed on the top line when the patient's temperature has reached the Set Point temperature.

C. During normal operation in *MONITOR ONLY MODE* the Status Display shows the following messages:

Status Display Message	Function
MONITOR ONLY CELSIUS	This message is displayed when the temperature scale is set to Celsius in <i>MONITOR ONLY MODE</i> .
MONITOR ONLY FAHRENHEIT	This message is displayed when the temperature scale is set to Fahrenheit in <i>MONITOR ONLY MODE</i> .

D. The following messages are warnings and indications shown in the Status Display:

Indication/Warning Message	Function
CHECK SETPT	<p>This message occurs for the following three possible reasons, followed by their remedial actions:</p> <ol style="list-style-type: none"> 1. During start up, when the operator turns the unit ON: <ol style="list-style-type: none"> a. Proceed by pressing the TEMP SET button to enter the Set Point temperature. 2. During start up, when the operator attempts to begin one of the three Automatic Control modes with a Patient Set Point temperature selected outside the range of 30°C - 40°C (86°F - 104°F). The unit will not permit the operator to proceed to the Automatic Control modes until the Patient Set Point temperature setting is corrected: <ol style="list-style-type: none"> a. Proceed by pressing the TEMP SET button and change the SET POINT temperature to bring it within the allowable range. 3. During operation, a "low water" condition could cause CHECK SETPT to indicate: <ol style="list-style-type: none"> a. Check the water level in the reservoir and fill the unit with water, as necessary. <p>Note: If the CHECK SETPT display flashes for five minutes, the alarm will sound until the operator proceeds to the next step. This alarm will also notify the operator if there has been an interruption in power.</p>
SET TEMPERATURE SETPT xxx.xY *	<p>* ("xxx.x" represents Temperature and "Y" represents Centigrade or Fahrenheit.) This message occurs when the "TEMP SET" button is pressed. The Status Display can now be changed by pressing the Up or Down arrow or verify the preset temperature of 37°C (98.6°F) on power-up.</p>
GRADIENT VARIABLE OFFSET xxY *	<p>* ("xx" represents Temperature and "Y" represents Centigrade or Fahrenheit.) This is displayed after the first press of the GRADIENT VARIABLE button, when the user is setting the BLANKETROL III in <i>GRADIENT VARIABLE MODE</i>. When this display is shown, the user can adjust the gradient variable offset.</p>
HIGH LIMIT REMOVE FROM SERVICE	<p>This message occurs when the high limit is triggered because the water in the BLANKETROL III equipment has reached the high temperature of 44.0°C ± 2°C (111.2°F ± 3.6°F). While this message is displayed, the trouble alarm will sound, and the heater and pump will turn off. The alarm silence key cannot silence this alarm. This message will continue to display and the trouble alarm will continue to sound until the unit is turned off using the ON/OFF switch or the power cord is disconnected from the power source. If the unit is unplugged before turning the ON/OFF switch, the power fail alarm will activate and the power fail LED will light. If the unit is turned back on, this message will reappear and the trouble alarm will sound. The unit cannot be used again until it is serviced. The seven-segment displays ("WATER" and "PATIENT") will both be blank during this condition. Contact GENTHERM Technical Service.</p>
HIGH LIMIT REMOVE FROM SERVICE	<p>This message occurs when the software fails and the water in the BLANKETROL III equipment has reached the high temperature limit of 44.0°C ± 2°C (111.2°F ± 3.6°F), activating the independent safety. While this message is displayed, the trouble alarm will sound, and the heater and pump will turn off. The alarm silence key cannot silence this alarm. This message will continue to display and the trouble alarm will continue to sound until the unit is turned off using the ON/OFF switch or the power cord is disconnected from the power source. If the unit is unplugged before turning the ON/OFF switch, the power fail alarm will activate and the power fail LED will light. If the unit is turned back on, this message will reappear and the trouble alarm will sound. The unit cannot be used again until it is serviced. The seven-segment displays ("WATER" and "PATIENT") will both be blank during this condition. Contact GENTHERM Technical Service.</p>
SNAP DISC REMOVE FROM SERVICE	<p>This message occurs when the thermostatic snap disc has opened or is disconnected, or when the reservoir temperature has exceeded 46°C ± 2°C (114.8 ± 3.6°F) causing the thermostatic disc to shut off heating. While this message is displayed, EE02** will display in the "PATIENT" temperature display, the trouble alarm will sound, and the heater, compressor and pump will turn off. The alarm silence key cannot silence this alarm. This message will continue to display and the trouble alarm will continue to sound until the unit is turned off using the ON/OFF switch or the power cord is disconnected from the power source. If the unit is unplugged before turning the ON/OFF switch, the power fail alarm will activate and the power fail LED will light. If the unit is turned back on, only "SNAP DISC" "REMOVE FROM SERVICE" will reappear and the trouble alarm will sound, even if disc has reset. The unit cannot be used again until it is serviced. Contact GENTHERM Technical Service.</p> <p>**EE02 appears when the thermostatic snap disc has opened or is disconnected.</p>
LOW LIMIT REMOVE FROM SERVICE	<p>This message occurs when the low limit is triggered because the water in the BLANKETROL III equipment has reached the low temperature limit of 2.0°C ± 2°C</p>

	<p>(35.6°F ± 3.6°F). While this message is displayed, the trouble alarm will sound, and the compressor and pump will turn off. The alarm silence key cannot silence this alarm. This message will continue to display and the trouble alarm will continue to sound until the unit is turned off using the ON/OFF switch or the power cord is disconnected from the power source. If the unit is unplugged before turning the ON/OFF switch, the power fail alarm will activate and the power fail LED will light. If the unit is turned back on, this message will reappear and the trouble alarm will sound. The unit cannot be used again until it is serviced. The seven-segment displays ("WATER" and "PATIENT") will both be blank during this condition. Contact GENTHERM Technical Service.</p>
<p>LOW LIMIT REMOVE FROM SERVICE</p>	<p>This message occurs when the software fails and the water in the BLANKETROL III equipment has reached the low temperature limit of 2.0°C ± 2°C (35.6°F ± 3.6°F), activating the independent safety. While this message is displayed, the trouble alarm will sound, and the compressor and pump will turn off. The alarm silence key cannot silence this alarm. This message will continue to display and the trouble alarm will continue to sound until the unit is turned off using the ON/OFF switch or the power cord is disconnected from the power source. If the unit is unplugged before turning the ON/OFF switch, the power fail alarm will activate and the power fail LED will light. If the unit is turned back on, this message will reappear and the trouble alarm will sound. The unit cannot be used again until it is serviced. The seven-segment displays ("WATER" and "PATIENT") will both be blank during this condition. Contact GENTHERM Technical Service.</p>
<p>EE01 REMOVE FROM SERVICE</p>	<p>This message occurs when EE01 appears in the PATIENT temperature display. Both messages appear when the backup processor does not agree with the primary processor. While both messages are displayed, the trouble alarm will sound, and the heater, compressor and pump will turn off. The alarm silence key cannot silence this alarm. Both messages will continue to display and the trouble alarm will continue to sound until the unit is turned off using the ON/OFF switch or the power cord is disconnected from the power source. If the unit is unplugged before turning the ON/OFF switch, the power fail alarm will activate and the power fail LED will light. If the unit is turned back on, only "EE01" "REMOVE FROM SERVICE" will reappear in the Status Display and the trouble alarm will sound. The unit cannot be used again until it is serviced. Contact GENTHERM Technical Service.</p>
<p>SENSOR FAULT REMOVE FROM SERVICE</p>	<p>This message will be displayed if the water temperature sensor is open or shorted. The trouble alarm will sound and this message will continue to display until the power cord is disconnected from the power source. The unit cannot be used again until it is serviced. While this message is displayed, the trouble alarm will sound, and the heat, compressor and pump will be off. The alarm silence key cannot silence this alarm. The seven-segment displays (WATER and PATIENT) will both be blank during this condition. This message will also be displayed if the WATER temperature is out of the range, 0°C – 52.0°C (32°F - 125.6°F), of the available temperature readout. Contact GENTHERM Technical Service.</p>
<p>CHECK PROBE</p>	<p>This message is displayed to alert the operator when the probe needs to be checked. For instance:</p> <ol style="list-style-type: none"> 1. If the probe is operating outside of the normal operating range of 30.0°C – 43.5°C (86°F to 110.3°F) during any automatic mode, this message will be displayed. 2. If the probe is not connected to the 1/4 inch receptacle prior to pressing any of the automatic modes button. 3. If the probe is dislodged from the patient. 4. If the PATIENT temperature falls below 30°C (86°F). 5. If the PATIENT temperature is greater than 43.5°C (110.3°F). 6. If the probe is defective or open. 7. If other than a 400 Series probe was connected to the 1/4 inch receptacle. <p>As this message is displayed, the trouble alarm sounds and the unit shuts down. The operator can silence the alarm by pressing the SILENCE ALARM button. After silencing the alarm and checking the probe, the operator must press the TEMP SET button to proceed; otherwise STATUS will continue to display CHECK PROBE. The operator has 5 minutes to fix the probe. If after that time the condition has not been cleared, the system will trouble alarm again, even though the SILENCE ALARM button has been previously pressed.</p> <p>In <i>MONITOR ONLY MODE</i>, CHECK PROBE is displayed if:</p> <ol style="list-style-type: none"> 1. The temperature goes out of the range 10.0°C – 50.0°C (50°F – 122.0°F). The trouble alarm sounds and cannot be silenced. The patient display is blank. If the temperature comes back into range, the unit should resume operation in <i>MONITOR ONLY MODE</i>. <p>In <i>MANUAL CONTROL MODE</i>, a probe out of range should result in the PATIENT display going blank, but the unit continuing operation with no error message. If the temperature comes back into range, the PATIENT display should come back on.</p>
<p>BAD PROBE</p>	<p>While in any of the three automatic modes, if the patient probe indicates only a direct short in the probe circuit this message occurs. As this message is displayed, the trouble alarm sounds and the unit shuts down. This alarm can be silenced using the SILENCE ALARM button. The</p>

	<p>operator then has 5 minutes to fix the probe. If after that time the condition has not been fixed, the system will trouble alarm again, even though the SILENCE ALARM button has been previously pressed. During this condition, the seven-segment displays will both be blank.</p> <p>While operating in <i>MANUAL CONTROL mode</i>, if a bad patient probe develops, the heating/cooling system remains on, but the seven-segment PATIENT display blanks.</p> <p>While operating in the <i>MONITOR ONLY mode</i>, if a bad patient probe develops, the BAD PROBE message displays, the audible alarm sounds and the "PATIENT" temperature display blanks. The audible alarm can be silenced using the SILENCE ALARM button. The operator then has 5 minutes to fix the probe. If after that time the condition has not been fixed, the system will trouble alarm again, even though the SILENCE ALARM button has been previously pressed. Connecting a working probe in range should clear the error message and return the unit to normal operation in <i>MONITOR ONLY mode</i>.</p>
LOW WATER	<p>This message occurs when the float switch senses that the water in the reservoir is below a preset level or the float switch is defective. The trouble alarm sounds, the seven-segment displays will be blank, the low water symbol LED will flash, and the heater, compressor and pump will turn off. The LCD display shall display the scrolling message "LOW WATER" for 5 seconds followed by "REPLENISH RESERVOIR" for 5 seconds followed by "PRESS Δ TO CONTINUE" and scroll between them until the increment key is pressed. The operator can silence this alarm using the "SILENCE ALARM" button. The condition can also be satisfied if the operator adds water to the reservoir and it reaches the proper level and the increment key has been pressed to clear the scrolling "LOW WATER" followed by "PRESS Δ TO CONTINUE" message. Once the LOW WATER condition is satisfied, the Status Display changes to show CHECK SETPT. The trouble alarm should still sound. In order to proceed, the operator must once again go through the operating mode button sequence. If the alarm is silenced, the operator has 5 minutes to add water. If after that time the condition has not been cleared, the system will trouble alarm again even though the SILENCE ALARM button has been previously pressed.</p>
LOW FLOW	<p>This message is displayed when the flow out of the unit to a blanket is reduced below 6 ± 3 GPH after an acceptable flow has been previously detected. Along with this message, a trouble alarm will sound. The operator can silence this alarm using the SILENCE ALARM button. The operator has 5 minutes to fix the condition. If after that time the condition has not been cleared, the system will trouble alarm again even though the SILENCE ALARM button has been previously pressed. The condition can also be satisfied if the flow increases above 6 ± 3 GPH.</p>
CHECK FLOW SWITCH	<p>This message will be displayed after the indicators are tested if the flow switch is closed upon initial power up of the unit. This indication results from a stuck flow switch. The audible alarm shall sound continuously for 30 seconds. After 30 seconds, the message will clear and the alarm will stop sounding. Pressing the SILENCE ALARM key while the alarm is sounding shall silence the alarm and clear the message. A unit with a bad flow switch is still operable; however, a LOW FLOW alarm will not sound when flow through the blanket is blocked.</p>
PM REQUIRED	<p>This message will be displayed after 500 hours of operation past the last time the (500 hour) counter was reset. The message will only be displayed for 5 seconds at power-up.</p> <p>Note: Only qualified Medical Equipment Service Technicians, Certified Biomedical Electronics Technicians, or Certified Clinical Engineers can reset the 500 hour counter after preventative maintenance has been performed.</p>
TOTAL HOURS	<p>This message displays the total hours of operation. To display this message, simultaneously press the Increment and Decrement buttons.</p>
HOURS UNTIL SERVICE	<p>This message displays the total number of hours of operation until the next required PM. To display this message, simultaneously press SILENCE ALARM and TEMP SET buttons.</p> <p>Note:</p> <ol style="list-style-type: none"> Maintenance should be performed at least quarterly or when indicated by 500 hour PM notification, whichever occurs first. Only qualified Medical Equipment Service Technicians, Certified Biomedical Electronics Technicians, or Certified Clinical Engineers can reset the Hours Until Service hour counter after preventative maintenance has been performed.
UNDER TEST	<p>This message is displayed while the unit is under test during preventative maintenance.</p>

SECTION 4. GENERAL MAINTENANCE OF THE BLANKETROL III System

4-1. INTRODUCTION

Maintenance and service activities will sometimes overlap. In general, maintenance refers to any activity that does not require a certified technician. Maintenance may be performed by healthcare personnel or by other trained persons.

The following actions are considered maintenance:

1. Inspecting, cleaning, and disinfecting the exterior
2. Adding or replacing water
3. Replacing hoses
4. Cleaning hoses, blankets
5. Draining reservoirs

Service refers to any activity that requires a Medical Equipment Service Technician, Certified Biomedical Electronics Technician, or a Certified Clinical Engineer. The following actions are considered service:

1. Equipment or parts replacement
2. Repairs
3. System testing
4. Cleaning & disinfecting water reservoirs
5. Replacing hoses (air, water), cords, and other accessories

Cleaning and Maintenance routine and preventive maintenance should be performed on the BLANKETROL III.

Maintenance, repair and/or service of BLANKETROL III by a qualified maintenance/technical personnel **will not** void the warranty of the unit.

After maintenance has been performed, the PM Required/HOURS UNTIL SERVICE hour counter should be reset back to 500 by a qualified Medical Equipment Service Technician, Certified Biomedical Electronics Technician, or Certified Clinical Engineer. See *Operational and Technical Manual*.

4-2. MAINTENANCE OF THE BLANKETROL III EXTERIOR – CLEANING INSTRUCTIONS

The BLANKETROL III unit is constructed of powder coated steel with a plastic top that should be cleaned quarterly with water and mild detergent solution. For cleaning and disinfecting, always use conventional hospital-approved topical equipment cleaners and disinfectants that do not contain alcohol. Avoid alcohol and other strong, undiluted disinfectants. These may cause staining of the device's outer skin. Thoroughly wipe down the device with a damp cloth to remove any residue from cleaning solutions.

Exterior Cleaning section:

- "This exterior cleaning procedure was validated using PDI Sani-Cloth® Bleach Germicidal Disposable Wipes."

Exterior Disinfection section:

- "This exterior disinfection procedure was validated using PDI Sani-Cloth® Bleach Germicidal Disposable Wipes."

Alternate: Medical Device cleaning/disinfecting bleach wipes with 0.63% Sodium Hypochlorite; ARTG 335509, 332716

4-3. MAINTENANCE OF THE WATER RESERVOIR

The dual compartment reservoir holds approximately 2 gallons (7.6 liters) of Sterile water or water that has been passed through a filter less than or equal to 0.22 microns that remains in the unit between periods of use. Quarterly, the water reservoir should be drained and replenished. The drain hose, included in the packaging of the unit, is attached and the water is pumped out of the unit. When the LOW WATER alarm sounds, the remaining water is drained by gravity. Sterile water or water that has been passed through a filter less than or equal to 0.22 microns is then poured into the reservoir.

NOTE: DO NOT USE DE-IONIZED WATER OR ALCOHOL.

Quarterly, at a minimum, the FLUID CIRCUIT DISINFECTION/DRY STORAGE PROCEDURE should be conducted.

Note: This interior reprocessing procedure was validated using Clorox Bleach Solution (8.25% v/v sodium hypochlorite).

Alternate Internal Cleaning Agent: Clorox Bleach Solution ARTG 405627

CAUTION	
	<ul style="list-style-type: none"> • For safe handling and use of chemicals follow manufacturer guidelines. • Users should not use cleaning or decontamination methods different from those recommended by GENTHERM without first checking with GENTHERM that the proposed methods will not damage the equipment. • Always drain the BLANKETROL III to a sanitary drain because bio-contaminants may be present in the unit's water supply.

Chemical Cleaning Circulation Chart

UNIT	MODE	TEMPERATURE	DURATION
BLANKETROL III	Heating	38°C	5 Minutes

**FLUID CIRCUIT DISINFECTION/DRY STORAGE PROCEDURE
for Circulating Water Units Utilizing Household Bleach**

The required tools/supplies:

Drain hose(s) and/or hose connector(s), household bleach, sterile water or water that has been passed through a filter less than or equal to 0.22 microns, and the appropriate AC electrical power

The following procedure disinfects the fluid circuit in these products.

PROCEDURE:

1. Drain the water from the reservoir as described in Section 4-2.1.
2. Turn unit **off** (“**O**” position).
3. Fill the reservoir with the appropriate amount of household bleach per the below chart.

UNIT	BLEACH	WATER
BLANKETROL III	227 Milliliters	7.6 Liters

4. Fill the reservoir with warm sterile water or water that has been passed through a filter less than or equal to 0.22 microns.
5. Turn the unit on and circulate per the Chemical Cleaning Circulation (CCC) Chart (above).
Note: The duration indicated in the CCC chart is meant to begin when the circulating water reaches the temperature indicated in the CCC chart.
6. Drain the unit as instructed in Step #1.
7. Rinse the unit three (3) times as described in Steps 4-6. Be sure to omit the household bleach (sodium hypochlorite).
8. After the third rinse, drain the unit and fill the reservoir with sterile water or water that has been passed through a filter less than or equal to 0.22 microns and circulate.
9. Check the water with pH strips or other appropriate test method for detecting bleach. If bleach is detected, repeat Steps 4-6.
10. Continue to fill the water reservoir with sterile water or water that has been passed through a filter less than or equal to 0.22 microns.
11. If unit is being **placed in dry storage**, continue with procedure.
12. When all fluid has been removed from the unit, disconnect the drain hose(s) and wipe unit clean.
13. Unit is now ready for storage.
14. Document unit maintenance.

When you are ready to return unit to service, replenish the reservoir(s) with sterile water or water that has been passed through a filter less than or equal to 0.22 microns. Perform all the checks as described in the respective Manual.

**FLUID CIRCUIT DISINFECTION/DRY STORAGE PROCEDURE
for Circulating Water Units Utilizing CE Approved Gigasept FF (Product of Schulke & Mayr) (Contact your local Cleaning Supplier)**

(Gigasept FF Is Not Available in the United States)

The following procedure disinfects the fluid circuit in these products. The required tools/supplies are appropriate drain hose(s) and/or hose connector(s), Gigasept FF, sterile water or water that has been passed through a filter less than or equal to 0.22 microns, and the appropriate AC electrical power

PROCEDURE:

1. Drain the water from the reservoir as described in Section 4-2.1.
2. Turn unit **off** (“**O**” position).
3. Fill the reservoir with the appropriate amount of Gigasept FF per the below chart.

UNIT	Gigasept FF	WATER	DURATION
BLANKETROL III	800 Milliliters	7.6 Liters	15 Minutes

4. Fill the reservoir with the appropriate amount of water per the above chart.
5. Turn the unit on and circulate in Heating Mode @ 38°C for 15 minutes.
Note: The 15 minutes should not begin until the water reaches 38°C.
6. Drain the unit as instructed in Step #1.
7. Rinse the unit with Sterile water or water that has been passed through a filter less than or equal to 0.22 microns three (3) times as described in Steps 4-6. **Be sure to omit Gigasept FF.**
8. After the third rinse, drain the unit and fill the reservoir with sterile water or water that has been passed through a filter less than or equal to 0.22 microns and circulate.
9. Check the water with PH strips or other appropriate test method for Gigasept FF detection. If Gigasept FF is detected, repeat Steps 4-6.
10. If unit is to be **returned to service**, replenish reservoir(s) with the appropriate volume of sterile water or water that has been passed through a filter less than or equal to 0.22 microns.
11. If unit is being **placed in dry storage**, continue with procedure.
12. When all fluid has been removed from the unit, disconnect the drain hose(s) and wipe unit clean.
13. Unit is now ready for storage.
14. Document unit maintenance.

**FLUID CIRCUIT DISINFECTION/DRY STORAGE PROCEDURE
for Circulating Water Units Utilizing CE Approved Maranon H (Product of Ecolab)
(Contact your local Cleaning Supplier)
(Maranon H Is Not Available In the United States)**

The following procedure disinfects the fluid circuit in these products. The required tools/supplies are appropriate drain hose(s) and/or hose connector(s), Maranon H, sterile water or water that has been passed through a filter less than or equal to 0.22 microns, and the appropriate AC electrical power

PROCEDURE:

1. Drain the water from the reservoir as described in Section 4-2.1.
2. Turn unit **off** ("**O**" position).
3. Fill the reservoir with the appropriate amount of Maranon H per the below chart.

UNIT	MARANON H	WATER
BLANKETROL III	227 Milliliters	7.6 Liters

4. Fill the reservoir with the appropriate amount of water per the above chart.
 5. Turn the unit on and circulate per the Chemical Cleaning Circulation (CCC) Chart (above).
- Note: The duration indicated in the CCC chart is meant to begin when the circulating water reaches the temperature indicated in the CCC chart.
6. Drain the unit as instructed in Step #1.
 7. Rinse the unit with sterile water or water that has been passed through a filter less than or equal to 0.22 microns **three (3) times** as described in Steps 4-6. **Be sure to omit the Maranon H.**
 8. After the third rinse, drain the unit and fill the reservoir with sterile water or water that has been passed through a filter less than or equal to 0.22 microns and circulate.
 9. Check the water with PH strips or other appropriate test method for Maranon H detection. If Maranon H is detected, repeat Steps 4-6.
 10. If unit is to be **returned to service**, replenish reservoir(s) with the appropriate volume of sterile water or water that has been passed through a filter less than or equal to 0.22 microns.
 11. If unit is being **placed in dry storage**, continue with procedure.
 12. When all fluid has been removed from the unit, disconnect the drain hose(s) and wipe unit clean.
 13. Unit is now ready for storage.
 14. Document unit maintenance.

4-3.1. Draining the Reservoir

- A. Collect these items:
 1. An empty container to drain the water into that can hold at least 3 gallons (11.4 liters).
 2. The drain hose with a female quick-disconnect fitting usually found in the storage drawer of the unit.
 3. 2 gallons (7.6 liters) sterile water or water that has been passed through a filter less than or equal to 0.22 microns to replenish the reservoir.
- B. Insert the drain end of the hose into the 3 gallon (11.4 liters) container. Set the container on the floor so the hose drains downward.
- C. Attach the female coupling of the drain hose to any one of the male outlet couplings on the right side of the unit.
 1. Slide back the collar of the female coupling.
 2. Insert the female coupling over the male coupling.
 3. Release the collar so the coupling 'Snaps' into position.
- D. Plug the power cord into a properly grounded power outlet.
- E. Place the power switch to the "I" position.
- F. Press the TEMP SET button.
- G. Press the MANUAL CONTROL button.

The water is pumped into the container until there is approximately ½ gallon (1.9 liters) of water remaining to be drained. The Status Display flashes LOW WATER and the alarm sounds. The unit shuts down, but the water continues to drain into the container because of gravitational pull.

- H. Press the SILENCE ALARM button.
- I. Press the power switch to the "O" position.
- J. Disconnect the power cord from the power source.
- K. After all the water has drained from the unit, disconnect the drain hose, wipe, clean and store in a dry environment without disinfecting. (Refer to Section (7.) specifications for storage conditions)
- L. Discard the water drained from the unit.

- M. If any other maintenance/repair is to be completed, go to the appropriate section, e.g., replacing the water filter. If not, go to Section (4-3.2.) to replenish the reservoir.

4-3.2. Replenishing the Reservoir

- A. Check that the drain hose is disconnected.
- B. Lift the water fill opening lid and gradually pour approximately 2 gallons (7.6 liters) of Sterile water or water that has been passed through a filter less than or equal to 0.22 microns into the reservoir (DO NOT USE ALCOHOL, TAP WATER, DISTILLED WATER, OR DE-IONIZED WATER).
- C. Stop pouring when the water reaches the strainer visible at the bottom of the water fill opening.
- D. Proceed with normal operations; always check the water level before starting.

4-4. MAINTENANCE OF THE HYPER-HYPOTHERMIA BLANKETS

This section describes the general maintenance for the reusable and disposable blankets. General maintenance tasks include cleaning, draining, and storing the blankets.

4-4.1 Reusable Blankets

Gentherm reusable blankets are constructed from biocompatible polyurethane/urethane. Stains and debris can be wiped away with mild soap and water. For cleaning and disinfecting, always use conventional hospital-approved topical cleaners and disinfectants that do not contain alcohol. Avoid alcohol and other strong, undiluted disinfectants. These may cause staining of the device's outer skin. Thoroughly rinse product with clear water to remove any residue from cleaning solutions. DO NOT use gas sterilization or autoclaving for cleaning and disinfecting the blankets.

To drain the water from the reusable blankets simply shut off power to the unit or shut off the operation of the manual or automatic mode and allow the water to drain from the blanket back into the Blanketrol unit.

To store PLASTIPAD® blankets, loosely coil the hose lengthwise into the center of the blanket. Fold the blanket lengthwise into the center, 1/3 from the left side and 1/3 from the right side. Do not fold the blankets width-wise, as doing so will crimp the tubing.

Disposal of blankets are done in a means consistent with hospital/institution policy/protocol for patient contact items.

4-4.2. Disposable, Single-Patient Use Blankets

The reusable blanket maintenance procedures do not apply to the disposable, single-patient use blankets. Disposal of blankets are done in a means consistent with hospital/institution policy/protocol for patient contact items.

4-5. MAINTENANCE OF REUSABLE THERMISTOR PROBES

The standard 400 Series probe consists of a thermistor temperature sensing element housed in a probe and attached to a plasticized vinyl-jacketed, shielded, lead wire terminated with a phone plug. Refer to the printed material enclosed with each probe regarding temperature specifications, cautions, maintenance, and disposal.

In general, clean with a damp cloth and mild detergent. When not in use, the probes should be loosely coiled and stored at room temperature. Never boil or autoclave the vinyl jacketed leadwire. Avoid contact with strong aromatic chlorinated, ketone, ether, or ester solvents.

CAUTION
<ul style="list-style-type: none"> ● Do not immerse probes or connecting cables in liquid. Failure to do so may result in damage to the probes.

When cleaning or sterilizing, the probe should be handled gently. Excessive pressure can stretch the covering and/or break the internal wires. At high temperatures, the vinyl softens and can be deformed by pressure and stress. DO NOT AUTOCLAVE.

Similar to the blankets, disposal of probes are done in a means consistent with hospital/institution policy/protocol for patient contact items.

See Operation and Technical Manual for details on how to perform maintenance



4-6. DISPOSAL OF THE BLANKETROL III UNIT

Medical devices that have come in contact with patients contain the risk of bio-contamination. This device generates no waste products or residues under normal use and normal cleaning routines. Follow local State and Hospital guidelines regarding disposal of medical devices at the end of their useful lives.

SECTION 5. SPECIFICATIONS AND CERTIFICATIONS OF THE BLANKETROL III

BLANKETROL III MODEL 233 FEATURES

<p style="text-align: center;">PHYSICAL</p> <p>Dimensions: 17"W x 17"D x 37.5"H (43.18cm. W x 43.18 cm. D x 95.25cm. H)</p> <p>Weight: Empty -131 lbs. (59.5kg) Shipping – 151 lbs. (68.5kg)</p> <p>Cabinet Construction: Powder coated steel with plastic top. Divided reservoir. Bottom air discharge. Built-in handle. Bumper guard. Storage Compartment. Four 4" non-conductive, 360° swivel-type locking casters.</p> <p>Ambient Temperature (during use): 15°C – 30°C (59°F – 86°F)</p> <p>Ambient Humidity (during use): 20% - 60%</p> <p>Maximum Contact Surface Temperature: 41°C (105.8°F)</p>	<p style="text-align: center;">SAFETY SYSTEM</p> <p>Maximum High Control Setting: 42.0°C (107.6°F)</p> <p>High Limit Safety: 44.0°C ± 2.0°C (111.2°F ± 3.6°F)</p> <p>High Limit Secondary Back-up Safety: 44.0°C ± 2.0°C (111.2°F ± 3.6°F)</p> <p>Thermostatic Snap Disc: 46.0°C ± 2.0°C (114.8°F ± 3.6°F)</p> <p>Minimum Low Control Setting: 4.0°C (39.2°F)</p> <p>Low Limit Safety: 2.0°C ± 2.0°C (35.6°F ± 3.6°F)</p> <p>Low Limit Secondary Back-up Safety: 2.0°C ± 2.0°C (35.6°F ± 3.6°F)</p> <p>Defective or Dislodged Probe Alarm: Audible & Visual</p> <p>Primary & Secondary High and Secondary Low Limit Failure Alarm: Audible & Visual</p> <p>Low Water Alarm: Audible & Visual</p> <p>Defective Water Temp Sensor: Audible & Visual</p> <p>Water Flow Indicator: Visual</p> <p>Low Flow Alarm: Audible & Visual</p> <p>Water Temperature Sensor Fault Alarm: Audible & Visual</p>
<p style="text-align: center;">THERMAL SYSTEM</p> <p>Compressor: 1/3 HP Heater: 800 Watts</p> <p>NOTE: Maximum expected heating capability approximately 3°C (5.4°F) per minute. Maximum expected cooling capability approximately 5.5°C (9.9°F) per minute. Time to heat from 23°C ± 2°C to 37°C is approximately 12 minutes with a blanket attached.</p>	
<p style="text-align: center;">CIRCULATING SYSTEM</p> <p>Divided Compartment Reservoir, 2 gallon (7.5 liters) total capacity. Error proof, quick-disconnect couplings.</p>	
<p style="text-align: center;">ELECTRICAL SYSTEM</p> <p>Electrical Characteristics: 115V-127V±10%, 60Hz., 10.2 Amps 220V-230V±10%, 50Hz., 5.2 Amps</p> <p>Power Cord: 14/3 SJT (115V), Hospital grade plug Standard European Cord (230V)</p> <p>Leakage Current: Under 300 µa (115V) Under 500 µa (230V)</p> <p>Circuit Breaker: In Power Switch Mains Isolation: Two-Pole Mains Switch</p>	

<p style="text-align: center;">CONTROL SYSTEM</p> <p>Microprocessor controlled, Lighted "OFF-ON" power switch, Digital LED Read Outs, Alarm Indications, and Mode Indications.</p> <p>Controller Range: Water Temp.: 4°C to 42°C (39.2°F to 107.6°F)</p> <p>Patient Temp.: 30°C to 40°C (86°F to 104°F)</p> <p>Display Accuracy: Water Temp. ± 0.5°C (± 1°F) (measured at 37°C)</p> <p>Patient Temp. ± 0.3°C (± .5°F)</p> <p>Display Range: Water Temp.: 0°C - 52°C (32°F - 126°F)</p> <p>Patient Temp.: MANUAL CONTROL: 10°C - 50.0°C (50°F - 122°F)</p> <p>AUTO MODES: 30.0°C - 43.5°C (86.0°F - 110.3°F)</p> <p>MONITOR ONLY: 10.0°C - 50.0°C (50°F - 122°F)</p> <p style="text-align: center;"><u>Service Life</u></p> <p>The expected service life/ lifetime of the Blanketrol III, Model 233 unit is twelve (12) years from the date of manufacture provided the product is not subject to misuse, negligence, accident or abuse and under the conditions that the device is properly used as intended, and serviced and maintained according to the Operation /Technical Manual provided with the device.</p>	<p style="text-align: center;">CONTROL SYSTEM (cont'd)</p> <p>Display Type: LED</p> <p>Temp. Settings: Water Temp.: 0.1°C (0.1°F) Patient Temp.: 0.1°C (0.1°F) Patient Probe ¼ inch receptacle: One Probe Type: 400 Series</p> <hr/> <p style="text-align: center;">ENVIROMENTAL CONDITIONS (during storage and transportation)</p> <p>Ambient Temperature (transportation and storage): -40°C - +50°C (-40°F - +122°F)</p> <p>Humidity (transportation and storage): 20% - 95%</p> <hr/> <p style="text-align: center;">WARRANTY</p> <p>2 yr. parts (Labor if returned to GENTHERM)</p> <p>Additional warranties available at time of purchase. Contact GENTHERM.</p>
<p style="text-align: center;">CLASSIFICATION</p> <p style="text-align: center;">Equipment is Class I.</p> <p style="text-align: center;">Equipment is Type BF.</p> <p style="text-align: center;">The blanket is a means of patient protection.</p> <div style="text-align: center;">   </div>	
<p style="text-align: center;">CERTIFICATIONS</p> <div style="display: flex; align-items: center;">  <div> <p>MODEL 233 MEDICAL ELECTRICAL EQUIPMENT WITH RESPECT TO ELECTRIC SHOCK, FIRE AND MECHANICAL HAZARDS ONLY IN ACCORDANCE WITH UL60601-1, IEC60601-1, IEC60601-2-35, ASTM F2196-02, IEC60601-1-2, AND CAN/CSA-C22.2 No. 601.1</p> </div> </div>	

The following tables are presented in fulfillment of the requirements of

IEC 60601-1-2

TABLE 5-1. GUIDANCE AND MANUFACTURER'S DECLARATION - ELECTROMAGNETIC EMISSIONS		
The BLANKETROL III, Model 233 is intended for use in the electromagnetic environment specified below. The customer or the user of the BLANKETROL III, Model 233 should assure that it is used in such an environment.		
Emissions tests	Compliance	Electromagnetic environment – guidance
RF emissions CISPR 11	Group 1	The BLANKETROL III, Model 233 uses RF energy only for its internal function. Therefore, its RF emissions are very low and are not likely to cause any interference in nearby electronic equipment.
RF emissions CISPR 11	Class A	The BLANKETROL III, Model 233 is suitable for use in all establishments other than domestic and those directly connected to the public low-voltage power supply network that supplies buildings used for domestic purposes.
Harmonic emissions IEC 61000-3-2	Class A	
Voltage fluctuations/ flicker emissions IEC 61000-3-3	Complies	

TABLE 5-2. GUIDANCE AND MANUFACTURER'S DECLARATION - ELECTROMAGNETIC IMMUNITY			
The BLANKETROL III, Model 233 is intended for use in the electromagnetic environment specified below. The customer or the user of the BLANKETROL III, Model 233 should assure that it is used in such an environment.			
Immunity test	IEC 60601 test level	Compliance level	Electromagnetic environment - guidance
Electrostatic discharge (ESD) IEC 61000-4-2	±6 kV contact ±8 kV air	±6 kV contact ±8 kV air	Floors should be wood, concrete or ceramic tile. If floors are covered with synthetic material, the relative humidity should be at least 30%.
Electrical fast transient/burst IEC 61000-4-4	±2 kV for power supply lines ±1 kV for input/output lines	±2 kV for power supply lines ±1 kV for input/output lines	Mains power quality should be that of a typical commercial or hospital environment.
Surge IEC 61000-4-5	±1 kV differential mode ±2 kV common mode	±1 kV differential mode ±2 kV common mode	Mains power quality should be that of a typical commercial or hospital environment.
Voltage dips, short interruptions and voltage variations on power supply input lines IEC 61000-4-11	<5% U_T (>95% dip in U_T) for 0,5 cycle 40% U_T (60% dip in U_T) for 5 cycles 70% U_T (30% dip in U_T) for 25 cycles <5% U_T (>95% dip in U_T) for 5 s	<5% U_T (>95% dip in U_T) for 0.5 cycle 40% U_T (60% dip in U_T) for 5 cycles 70% U_T (30% dip in U_T) for 25 cycles <5% U_T (>95% dip in U_T) for 5 s	Mains power quality should be that of a typical commercial or hospital environment. If the user of the BLANKETROL III, Model 233 requires continued operation during power mains interruptions, it is recommended that the BLANKETROL III, Model 233 be powered from an uninterruptible power supply or a battery.
Power frequency (50/60 Hz) magnetic field IEC 61000-4-8	3 A/m	3 A/m	Power frequency magnetic fields should be at levels characteristic of a typical location in a typical commercial or hospital environment.
Note: U_T is the a.c. mains voltage prior to application of the test level.			

TABLE 5-3. GUIDANCE AND MANUFACTURER'S DECLARATION - ELECTROMAGNETIC IMMUNITY			
The BLANKETROL III, Model 233 is intended for use in the electromagnetic environment specified below. The customer or the user of the BLANKETROL III, Model 233 should assure that it is used in such an environment.			
Immunity test	IEC 60601 test level	Compliance level	Electromagnetic environment - guidance
Conducted RF IEC 61000-4-6	3 Vrms 150 kHz to 80 MHz	3 Vrms	<p>Portable and mobile RF communications equipment should be used no closer to any part of the BLANKETROL III, Model 233, including cables, than the recommended separation distance calculated from the equation applicable to the frequency of the transmitter.</p> <p>Recommended separation distance</p> $d = 1,2\sqrt{P}$
Radiated RF IEC 61000-4-3	3 V/m 80 MHz to 2,5 GHz	3 V/m	$d = 1,2\sqrt{P} \quad 80 \text{ MHz to } 800 \text{ MHz}$ $d = 2,3\sqrt{P} \quad 800 \text{ MHz to } 2,5 \text{ GHz}$ <p>Where P is the maximum output power rating of the transmitter in watts (W) according to the transmitter manufacturer and d is the recommended separation distance in meters (m).</p> <p>Field strengths from fixed RF transmitters, as determined by an electromagnetic site survey,^a should be less than the compliance level in each frequency range.^b</p> <p>Interference may occur in the vicinity of equipment marked with the following symbol:</p> 
<p>NOTE 1: At 80 MHz and 800 MHz, the higher frequency range applies.</p> <p>NOTE 2: These guidelines may not apply in all situations. Electromagnetic propagation is affected by absorption and reflection from structures, objects and people.</p>			
<p>^a Field strengths from fixed transmitters, such as base stations for radio (cellular/cordless) telephones and land mobile radios, amateur radio, AM and FM radio broadcast and TV broadcast cannot be predicated theoretically with accuracy. To assess the electromagnetic environment due to fixed RF transmitters, an electromagnetic site survey should be considered. If the measure field strength in the location in which the BLANKETROL III, Model 233 is used exceeds the applicable RF compliance level above, the BLANKETROL III, Model 233 should be observed to verify normal operation. If abnormal performance is observed, additional measures may be necessary, such as re-orienting or relocating the BLANKETROL III, Model 233.</p>			
<p>^b Over the frequency range 150 kHz to 80 MHz, field strengths should be less than 3 V/m.</p>			

TABLE 5-4. RECOMMENDED SEPARATION DISTANCE BETWEEN PORTABLE AND MOBILE RF COMMUNICATIONS EQUIPMENT AND THE BLANKETROL III, MODEL 233

The BLANKETROL III, Model 233 is intended for use in an electromagnetic environment in which radiated RF disturbances are controlled. The customer or the user of the BLANKETROL III, Model 233 can help prevent electromagnetic interference by maintaining a minimum distance between portable and mobile RF communications equipment (transmitters) and the BLANKETROL III, Model 233 as recommended below, according to the maximum output power of the communications equipment.

Rated maximum output power of transmitter W	Separation distance according to frequency of transmitter m		
	150 kHz to 80 MHz $d = 1,2\sqrt{P}$	80 MHz to 800 MHz $d = 1,2\sqrt{P}$	800 MHz to 2,5 GHz $d = 2,3\sqrt{P}$
0,01	0,12	0,12	0,23
0,1	0,38	0,38	0,73
1	1,2	1,2	2,3
10	3,8	3,8	7,3
100	12	12	23

For transmitters rated at a maximum output power not listed above, the recommended separation distance d in meters (m) can be estimated using the equation applicable to the frequency of the transmitter, where P is the maximum output power rating of the transmitter in watts (W) according to the transmitter manufacturer.

Note 1: At 80 MHz and 800 MHz, the separation distance for the higher frequency range applies.

Note 2: These guidelines may not apply in all situations. Electromagnetic propagation is affected by absorption and reflection from structures, objects and people.

Worldwide Order Placement

Telephone.....1-800-989-7373
Fax.....1-513-772-9119
(U.S.) 24hr Clinical Support ...1-513-460-2038
Med Tech Support.....1-888-437-5608

GENTHERM



Gentherm Medical, LLC
12011 Mosteller Road
Cincinnati, OH 45241

Toll Free: 1-800-989-7373

www.gentherm.com

Fax: (513) 772-9119