

Instructions for use

ASTOTHERM[®]plus

Warmer for Blood, Intravenous
Fluids and Irrigation Fluids

REF AP220
REF AP220S
REF AP260
REF AP260S



Order No. 0450.7200.12NA Rev. 04 07/2020

STIHLER ELECTRONIC

STIHLER ELECTRONIC GmbH • 70771 Leinfelden - Echterdingen • Germany

To be filled in by the user:

Serial number

Registration number

Device location

Start-up date

**Manufacturer: STIHLER ELECTRONIC GmbH
Gaussstrasse 4
70771 Leinfelden - Echterdingen
GERMANY
Tel. +49 (0) 711-720670
Fax +49 (0) 711-7206757
www.stihlerelectronic.de
E-Mail: info@stihlerelectronic.de**

© 2020 STIHLER ELECTRONIC GmbH

Contents

| | |
|--|-----------|
| 1 Information about these instructions | 5 |
| 2 General information | 5 |
| 2.1 Guarantee conditions..... | 5 |
| 2.2 Liability..... | 5 |
| 2.3 Disposal of the equipment | 6 |
| 2.4 Return of a used product | 6 |
| 2.5 Service information | 6 |
| 3 Important safety information..... | 7 |
| 3.1 Dangers | 7 |
| 3.2 Warnings | 7 |
| 3.3 Cautions | 11 |
| 3.4 Notices..... | 12 |
| 4 Specification of application..... | 13 |
| 4.1 Intended use | 13 |
| 4.2 Intended medical indication | 13 |
| 4.3 Contraindications..... | 13 |
| 4.4 Possible adverse effects..... | 13 |
| 4.5 Intended patient population | 13 |
| 4.6 Intended user profile | 13 |
| 4.7 Intended use/operation environment | 13 |
| 4.8 Intended part of the body/type of tissue..... | 14 |
| 5 Symbols | 15 |
| 6 Product description..... | 17 |
| 6.1 Introduction..... | 17 |
| 6.2 Technical description..... | 17 |
| 6.3 Components of the ASTOTHERM PLUS..... | 21 |
| 6.4 Applied part ASTOLINE..... | 22 |
| 6.5 Control panel | 23 |
| 7 Operating states | 25 |
| 7.1 Standby mode | 25 |
| 7.2 On mode..... | 26 |
| 7.3 Heating mode | 27 |
| 7.4 Increasing/Decreasing the setpoint temperature | 28 |
| 7.5 ASTOLINE* On mode..... | 29 |
| 7.6 ASTOLINE* Off mode..... | 29 |
| 8 Installation | 30 |
| 8.1 Initial start-up..... | 30 |
| 8.2 Installation of the warmer..... | 30 |
| 9 Getting started..... | 31 |
| 9.1 Preparation for use | 31 |
| 9.2 Inserting the infusion line, priming and starting the infusion | 34 |
| 9.3 After use | 38 |
| 9.4 Cleaning and disinfecting..... | 39 |

| | |
|---|-----------|
| 10 Alarms and troubleshooting | 41 |
| 10.1 Low temperature alarm..... | 42 |
| 10.2 Overheating alarm | 43 |
| 10.3 Cable break alarm | 44 |
| 10.4 ASTOLINE alarm ("S" models only)..... | 45 |
| 10.5 Processor alarm..... | 46 |
| 10.6 Standby mode - failure..... | 47 |
| 11 Brief overview of operating states and alarms | 48 |
| 11.1 Overview of operating states | 48 |
| 11.2 Overview of alarms | 49 |
| 12 Maintenance | 50 |
| 12.1 Recurrent tests | 50 |
| 12.2 Set up for electrical tests | 57 |
| 12.3 Test protocol | 58 |
| 13 Technical data | 60 |
| 14 Compliance with international standards | 61 |
| 15 Ordering information, accessories and consumables | 62 |
| 16 Guidelines and manufacturer's declaration | 63 |

1 Information about these instructions



- **Carefully read the entire instructions for use before using the device.**
- **Correct and safe operation can only be guaranteed if the instructions for use are observed.**
- **Incorrect use can result in damage to the product or to other property and/or personal injury.**
- **Keep the instructions for use for future reference.**
- **Only use the device for the intended purpose as described in these instructions for use. Refer to *chapter 4 Specification of application*.**

2 General information

2.1 Guarantee conditions

The guarantee period is 12 months. During this guarantee period the manufacturer will repair or replace free of charge all defects caused as a result of material or manufacturing errors.

Other damage is not subject to this guarantee. The guarantee does not include cases of misuse or incorrect handling, use of force, or damage caused by normal wear and tear. This applies also to changes undertaken by persons who are not authorised by the manufacturer and to modifications to the original condition.

If the equipment is damaged during the guarantee period, send the cleaned equipment to the nearest sales point or directly to STIHLER ELECTRONIC GmbH. The sender is responsible for any transport and packaging costs.

2.2 Liability

The manufacturer is only liable for the safety, reliability and performance of the equipment

- if all operating, servicing, and calibration procedures have been carried out by trained and qualified persons according to the procedures published by the manufacturer;
- if only original spare parts have been used to replace components as needed;
- if assembly and repairs are only carried out by authorised personnel or an authorised service centre;
- if the electrical installations satisfy the locally applicable regulations and the IEC/EN requirements and
- if the equipment is used for its intended purpose and at a suitable location in accordance with the instructions for use.

2.3 Disposal of the equipment

Electrical devices are recoverable waste and should not be disposed of in domestic waste at the end of their service life. Please follow the local rules for the disposal of used products, or send the cleaned and disinfected equipment with a corresponding note to STIHLER ELECTRONIC GmbH or your closest sales point. This will ensure the most cost efficient and proper disposal of your old equipment.



Follow the national regulations on the disposal of medical products.

2.4 Return of a used product

A report must be sent together with the equipment, detailing the precise reasons, circumstances, and, if known, the cause of the return. To prevent transportation damage, the equipment should be shipped either in the original packaging or in other, well-protected packaging.

WARNING

Risk of infection!

Clean and disinfect the equipment after every use and before you return the equipment for repairs.

NOTICE

The customer is responsible for the proper packaging and labelling of returns.

2.5 Service information

For service or technical support, please contact your local sales point or the following:

STIHLER ELECTRONIC GmbH
Gaussstrasse 4
70771 Leinfelden - Echterdingen
GERMANY

Tel. +49 (0) 711-720670
Fax +49 (0) 711-7206757
www.stihlerelectronic.de
E-Mail: info@stihlerelectronic.de

3 Important safety information

These Instructions for Use indicate and define the following safety information:

DANGER

DANGER indicates a hazardous situation which, if not avoided, will result in death or serious injury.

WARNING

WARNING indicates a hazardous situation which, if not avoided, could result in death or serious injury.

CAUTION

CAUTION indicates a hazardous situation which, if not avoided, may result in minor or moderate injury.

NOTICE

NOTICE indicates a property damage message.

3.1 Dangers

DANGER

Risk of explosion!

Do not use the ASTOTHERM PLUS in an environment at risk of explosion or in the presence of flammable anesthetics.

3.2 Warnings

WARNING

Risk of injury!

- Use of the ASTOTHERM PLUS must be carried out under the supervision of a physician.
- Read and observe all instructions, stickers, and accompanying documentation enclosed with the medical device. Failure to observe the instructions, including warnings and safety information, can result in incorrect handling, patient injury, injury to users or medical personnel, damage to the device, or material damage.
- Operate and service this equipment only in accordance with the procedures described in these instructions and with the applicable standards, rules, and guidelines. The manufacturer shall not be responsible for the safety of users or patients if any actions/procedures other than those published are carried out during operation, servicing, or recurrent tests.



Risk of injury!

- This device may only be operated by appropriately trained and medically qualified healthcare professionals.
- The service personnel must be appropriately trained and qualified.
- Do not use the ASTOTHERM PLUS until the following error conditions have been remedied through appropriate corrective action:
 - Damaged or worn cables, plugs, or connecting socket.
 - Damaged housing, damaged or loose control panel.
 - Device has been exposed to mechanical impact / exposed to severe shock or exposed to liquid.
 - Alarm without knowing the cause.
 - Damaged ASTOLINE („S“-models only), e.g. caused by clamps, scissors or improper handling or storage.
 - Damaged or missing markings/safety signs/warnings on the warmer and/or ASTOLINE.
- If the yellow “Alarm” LED and the acoustic alarm signal are not activated automatically, when the device turns on by pressing the “Standby” button, remove the device from service immediately.
- In the event of an overheating alarm proceed as outlined below:
 1. Ensure that the ASTOTHERM PLUS safety system has deactivated the heating function and that the temperature is dropping below 43°C. If the temperature is not dropping, stop the treatment to prevent fluid from returning to the patient. Remove the applicable tubing immediately from the heat exchanger. Further evaluation should be carried out by qualified medical personnel such as a physician before blood in the line can be reinfused.
 2. Consider the possible reasons for the alarm. For further information see **chapter 10 Alarms and troubleshooting**. If in doubt, do not continue using the warmer.
- The mains cable should not touch the patient and should not hinder the treating personnel.
- The ASTOTHERM PLUS does not contain any parts the user can repair. Therefore, do not attempt to repair the ASTOTHERM PLUS yourself. Contact your local sales point.
- Any repairs (such as, but not limited to, changing the power supply cord) to the equipment may only be carried out by persons authorized and qualified by the manufacturer.
- Modifications to the device are not permitted.

 **WARNING****Risk of overheating!**

- ASTOLINE („S“-models only) must hang freely while in use. Do not kink, cover (not even partially), clamp (for example, with a surgical clamp) or roll ASTOLINE.
- Do not place ASTOLINE under or directly beside the patient. Heat build-up can occur and/or the infusion extension can be squeezed off.
- Do not kink or clamp ASTOLINE during storage, to avoid internal damage.

 **WARNING****Risk of haemolysis!**

Make sure that the infusion line is not kinked.

 **WARNING****Risk of air embolism!**

- When fluids are warmed up, it is possible that gas may evolve (bubble form).
- Be aware of the potential for air emboli when using a blood and fluid warmer.
- Therefore prime all filters, lines and disposable sets before starting a treatment.
- Make sure all connections of the complete fluid stream are fixed tightly to prevent fluid leakages and inadvertent infusion of air into the fluid stream.
- Do not warm infusions containing soluted gas (e.g. bicarbonate).
- Extreme care should always be taken to ensure that a bolus of air does not pass to the patient.

 **WARNING****Risk of infection!**

- Use aseptic procedures.
- Clean and disinfect the warmer after every use and before you return the warmer for repairs.

 **WARNING****Risk of electric shock!**

- To avoid the risk of electric shock, this equipment must only be connected to a supply mains with protective earth.
- Do not use mains adapters that interrupt the earth conductor.
- Do not open the ASTOTHERM PLUS housing.
- If several pieces of equipment are combined or connected together (e.g., in multiple socket outlets), the total leakage currents must not exceed the allowable limits (refer to the respective national regulations). Observe the requirements as stipulated in IEC/EN 60601-1 regarding medical electrical systems.
- All electrical installations must conform to the applicable electrical standards and the specifications defined by the manufacturer.
- Before every use, check to make sure that the ASTOTHERM PLUS and the ASTOLINE are undamaged.
- The mains plug must be removed from the socket to fully disconnect the ASTOTHERM PLUS from the mains.

 **WARNING****Risk of radio interference!**

- Use of this equipment adjacent to or stacked with other equipment should be avoided because it could result in improper operation. If such use is necessary, this equipment and the other equipment should be observed to verify that they are operating normally.
- Use of accessories, other than those specified or provided by the manufacturer of this equipment could result in increased electromagnetic emissions or decreased electromagnetic immunity of this equipment and result in improper operation.
- Portable RF communications equipment (including peripherals such as antenna cables and external antennas) should be used no closer than 30 cm (12 inches) to any part of the ASTOTHERM PLUS, including cables specified by the manufacturer. Otherwise, degradation of the performance of this equipment could result.

3.3 Cautions



CAUTION

Risk of injury!

- Federal law (USA) restricts this device to sale by or on the order of a physician.
- When fixing the warmer to a mounting device, pay attention to the max. load to avoid tilting. Using normal infusion stands ASTOTHERM PLUS may be mounted at a height of up to 165 cm. If you use the robust IV pole ASTOSTAND, the device can be mounted up to 180 cm.
- Use only approved infusion sets / infusion extensions (e. g. ASTOTUBE, see **chapter 15 Ordering information, accessories and consumables**).

Damage to ASTOLINE can cause overheating, therefore follow the instructions below:

- Only disinfect ASTOLINE with alcohol-based agents or an approved disinfectant.
- Do not use solutions containing hypochlorite (bleach) for disinfecting ASTOLINE.
- Do not kink or pull excessively ASTOLINE.
- Do not use any clamps or sharp instruments on ASTOLINE as damage to ASTOLINE or the infusion line inside may result.
- Use narrow plaster strips or other narrow, soft fixation methods (for example cannula fixation, tube holder or Velcro®) to fix ASTOLINE.
- Do not use cleaning and disinfection procedures which differ from the procedure described.



CAUTION

Risk of hypothermia!

- When ASTOTHERM PLUS is used, the patient's body temperature must be monitored at regular intervals.
- The specified heating performance will only be achieved by inserting the infusion extension into the entire heat exchanger and, if applicable, in the entire length of ASTOLINE.
- The temperature control of the ASTOTHERM PLUS controls and monitors the current temperature of the heat exchanger, but not the patient's body temperature.
- If the ASTOTHERM PLUS cannot be started or if the patient's temperature balance is insufficient, consider the use of alternative warming methods in order to avoid or reduce hypothermia or to improve the patient's well-being.

 **CAUTION****Risk of needle dislodgement!**

The weight of ASTOLINE („S“-models only) pulls on the patient’s infusion line. Carefully secure the patient’s access against pulling. Attach the ASTOLINE by suitable methods (e.g. tape, plaster or Velcro®).

 **CAUTION****Risk of radio interference!**

- The essential performance can be lost or degraded due to EM disturbances. As a result, there is the possibility of hypothermia of the patient.
- According to the standard IEC/EN 60601-1-2, medical electrical equipment requires special precautions regarding electromagnetic compatibility (EMC) and needs to be installed and put into service according the EMC information provided.
- This device/system may cause radio interference or may disrupt the operation of nearby devices. It may be necessary to take mitigation measures, such as re-orienting or relocating of ASTOTHERM PLUS or shielding the location.

3.4 Notices**NOTICE**

- To avoid damage to the warmer:
 - Do not immerse the warmer or ASTOLINE in liquid.
 - Do not disinfect the warmer with these methods:
 - steam (autoclave)
 - hot air
 - thermo-chemical cleaning solutions.
 - Refer to the specific instructions for use of the disinfectants.
- To avoid damaging during storage, place ASTOLINE loosely around the warmer and do not kink or clamp it. Use narrow plaster strips or other narrow, soft fixation methods (for example cannula fixation, tube holder or Velcro®) to fix ASTOLINE.
- The customer is responsible for the proper packaging and labelling of returns.
- Only the active insulation ASTOLINE must be connected to the appliance socket of the “S” models.

4 Specification of application

4.1 Intended use

ASTOTHERM PLUS is a warmer for warming transfusions, infusions and for warming blood transfusions and return flow.

4.2 Intended medical indication

The warming of medical fluids with ASTOTHERM PLUS supports the prevention and therapy of hypothermia.

4.3 Contraindications

There are no known contraindications for warming blood, intravenous fluids and irrigation fluids.

4.4 Possible adverse effects

When the ASTOTHERM PLUS is used as a warmer for return blood flow in a haemofiltration, haemodialysis or haemodiafiltration device, it must be ensured that the entire system meets the following:

The highest set temperature (43°C) must be used with care when operating at low effluent flow rates (below 500 ml/h) for patients who weigh less than 30 kg. Global positive heat balance and net patient warming may occur. If necessary, operate the warmer at a reduced temperature setting.

4.5 Intended patient population

There are no restrictions for the intended patient group.

4.6 Intended user profile

The ASTOTHERM PLUS Warmer is to be operated only by medically qualified and trained healthcare professionals.





4.7 Intended use/operation environment







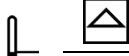



- The warmer may only be used in professional healthcare facilities (e.g. hospital, emergency care, dialysis, including HF surgical equipment, etc.).
- The warmer is not intended for home healthcare environment.
- The warmer is reusable, but requires cleaning / disinfection between the applications.
- Appropriate medical hygienic factors must be applied for the use of the warmer.
- The warmer must not be used in an environment at risk of explosion or in the present of flammable anesthetics.















4.8 Intended part of the body/type of tissue

The warmer is used to warm blood or other medical fluids supplied to the body. The fluids are physically separated from the warmer by disposable parts (tubes). The optional applied part ASTOLINE may have skin contact.

5 Symbols

| Symbols, used on the Control Panel | |
|---|--|
|  | Alarm condition if the yellow “Alarm” LED lights |
|  | “Standby” button. The Warmer is in Standby Mode if the blue LED is on |
|  | “Start” button. The Warmer is in Heating Mode , if the green LED is on |
|  | “Increase” button increases the setpoint temperature |
|  | “Decrease” button decreases the setpoint temperature |
|  | “ASTOLINE” button for switching On/Off the active insulation |

| Where these symbols are applicable, they appear at the relevant point on the device, the package, the rating plate or in the accompanying paperwork. | |
|--|--|
|  | Defibrillation-proof type B applied part in accordance with IEC/EN 60601-1 |
| IPX 4 | Splash proof in accordance to IEC/EN 60529 |
|  | Refer to instructions for use! / Follow instructions for use! |
|  | Caution: Federal US law restricts this device to sale by or on order of a physician. |
|  | General warning sign |
|  | Catalogue number |
|  | Serial number |
|  | Year of manufacture |
|  | Manufacturer |
|  | Prohibition: Do not cover the active insulation ASTOLINE – risk of overheating! |
|  | Prohibition: Do not clamp the active insulation ASTOLINE – risk of damage and possible overheating! |
|  | Prohibition: Do not disinfect the active insulation ASTOLINE with Hypochlorite solution – risk of damage and possible overheating! |

| | |
|---|--|
|  | Symbol at the connector for potential equalization according IEC/EN 60601-1 |
|  | Electrical devices are valuable products and should not be thrown in dustbin when they reach the end of their serviceable life. |
|  | MEDICAL – GENERAL MEDICAL EQUIPMENT AS TO ELECTRICAL SHOCK, FIRE AND MECHANICAL HAZARDS ONLY IN ACCORDANCE WITH standards ANSI/AAMI ES60601-1:2005/(R)2012 and A1:2012), C1:2009/(R)2012 and A2:2010/(R):2012 CAN/CSA-C22.2 No. 60601-1:2014. Control No. 75JA |
|  | This symbol indicates additional information. |
|  | Indicates the temperature range within which the package must be stored and handled. |
|  | Indicates the ambient humidity range within which the package must be stored and handled. |
|  | Indicates the pressure range within the package must be stored and handled. |
|  | Indicates the upright position of the package |
|  | The package must be kept in a dry environment. |
|  | The contents of the package are fragile and must therefore be handled with care. Do not drop or throw. |
|  | Recyclable - Polystyrene (acc. GB 18455-2001) |
|  | Recyclable - Cardboard (acc. GB 18455-2001) |
|  | Acoustic alarm signal |
|  | No acoustic alarm signal |

6 Product description

6.1 Introduction

ASTOTHERM PLUS consists of a stand-alone Warmer and optionally of the additional active insulation ASTOLINE („S“-models).

ASTOTHERM PLUS is a device for specific heating of blood and fluids which are delivered to the patients by transfusion, infusion or irrigation. The warming of the liquid supports the prevention and therapy of hypothermia during or after surgery; during longer procedures such as dialysis, hemofiltration, or apheresis the warming leads to a well-being. The applications of the ASTOTHERM PLUS therefore include transfusion, infusion, dialysis, hemofiltration and apheresis.

The ASTOTHERM PLUS Warmer can be used to warm fluids administered to a patient at flow rates of 0 to 6000 ml/h (i.e. 0 to 100 ml/min), see **figures 1 to 4**.

In the case of low flow rates, the re-cooling of the heated fluid on the way from the warmer to the patient is limited by using the active insulation ASTOLINE („S“ models only). The heated flexible silicone body surrounds the infusion extension on the way to the patient, ensuring that the part of the infusion line which would otherwise be exposed to cool ambient air is insulated and heated. Its special shape also enables infusions and transfusions to be observed all the way to the patient.

The active insulation ASTOLINE and the infusion extension ASTOTUBE are considered as applied part acc. to IEC/EN 60601-1.

6.2 Technical description

During operation of the Warmer heat is transferred from the internal heating element to the heat exchanger. Infusion extensions can simply be inserted in the circumferential groove. The heat from the heat exchanger is transferred through the inserted infusion extension to the fluid to be warmed.

The temperature of the heat exchanger is monitored by a microprocessor controlled temperature control system and by two independent alarm systems designed to alert the operator to failure conditions and, if necessary, to switch off the heating process automatically in the event of excessively high temperatures.

During operation, the mean temperature of the heat exchanger is displayed; this is not equal to the temperature of the medium to be warmed. ASTOTHERM PLUS neither regulates nor monitors/displays the current temperature of the medium to be warmed. The temperature of the medium (fluid) depends on a variety of factors, such as, but not limited to additional factors:

- room temperature and ventilation
- inlet temperature of the fluid (warmed-up or cold)
- flow rate

The heat protection sleeve (option) protects infusions from the effects of external cold (e.g. air condition) and prevents heat being given off into the room.

 **CAUTION****Risk of hypothermia!**

- When ASTOTHERM PLUS is used, the patient's body temperature must be monitored at regular intervals.
- The specified heating performance will only be achieved by inserting the infusion extension into the entire heat exchanger and, if applicable, in the entire length of ASTOLINE.
- The temperature control of the ASTOTHERM PLUS controls and monitors the current temperature of the heat exchanger, but not the patient's body temperature.
- If the ASTOTHERM PLUS cannot be started or if the patient's temperature balance is insufficient, consider the use of alternative warming methods in order to avoid or reduce hypothermia or to improve the patient's well-being.

Typical temperature curves are shown in the following figures.

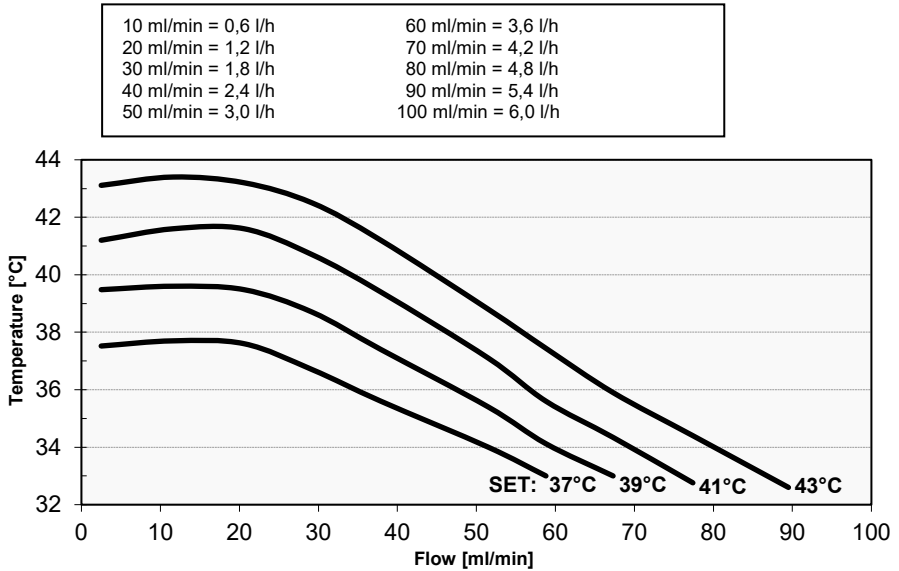

Fig. 1: Fluid outlet temperature (device outlet) at 10°C inlet temperature model AP220 without ASTOLINE

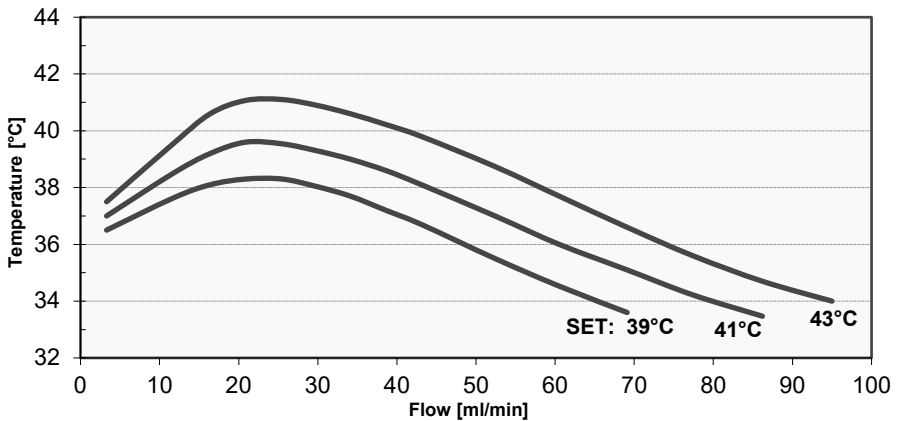

Fig. 2: Fluid outlet temperature (patient connection) at 20°C inlet temperature model AP220S with ASTOLINE

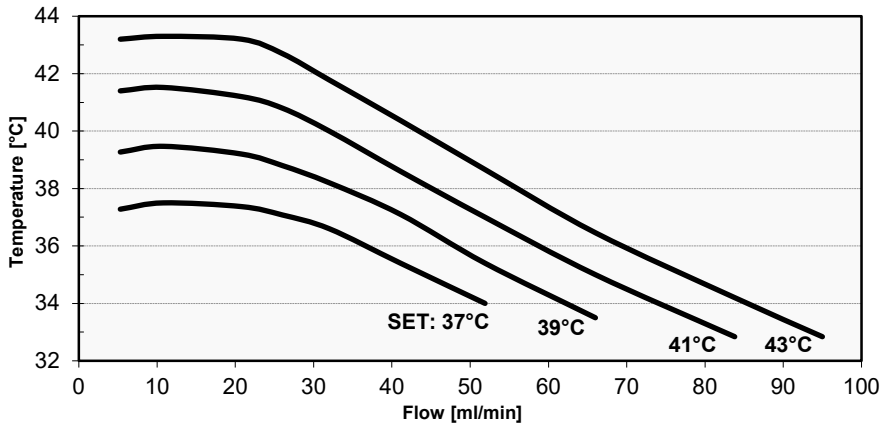

Fig. 3: Fluid outlet temperature (device outlet) at 20°C inlet temperature model AP260 without ASTOLINE

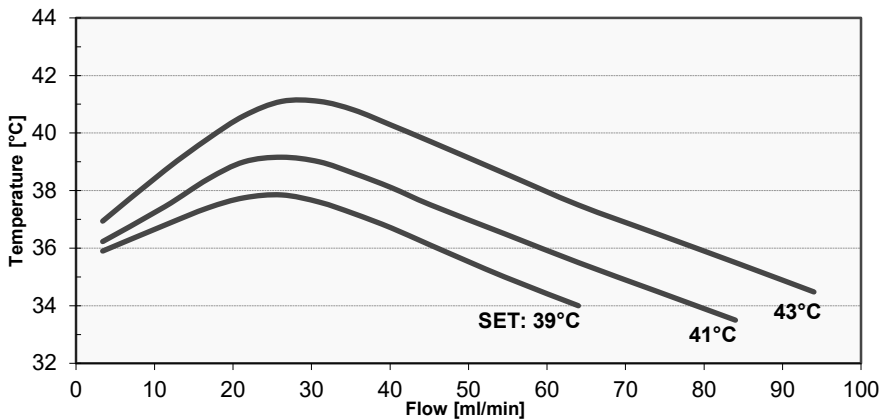

Fig. 4: Fluid outlet temperature (patient connection) at 20°C inlet temperature model AP260S with ASTOLINE

6.3 Components of the ASTOTHERM PLUS

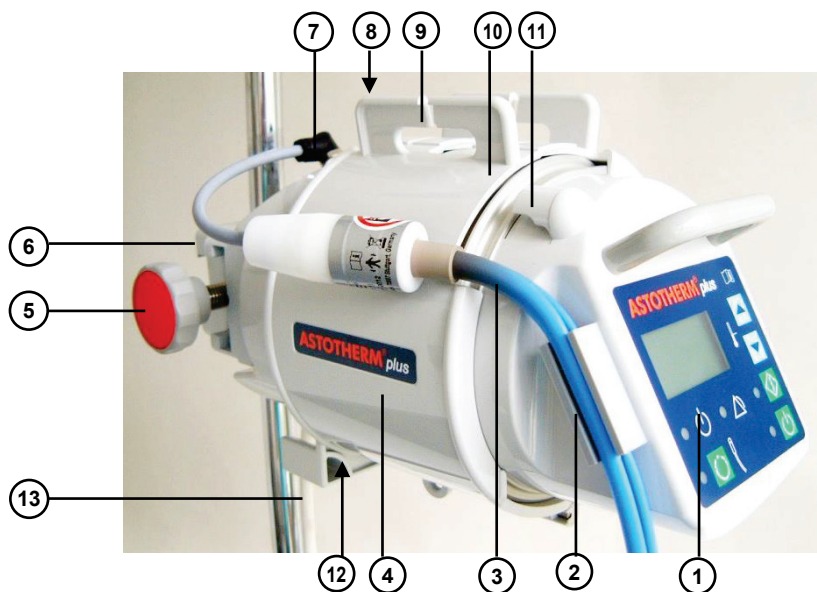

Fig. 5: ASTOTHERM PLUS (AP220S)

| # | Item | Description |
|----|-------------------------------|--|
| 1 | Control Panel | Control buttons and displays. (s. chapter 6.5 Control panel) |
| 2 | Bracket* | Fixes ASTOLINE* |
| 3 | ASTOLINE* | Active insulation of the infusion extension up to the patient (s. a. figure 6). |
| 4 | Heat Protection Sleeve** | Reduces the effect of environment and minimizes the radiation of heat. |
| 5 | Screw with Star Grip | For adapting the attachment device to infusion stands of different diameters. |
| 6 | Universal Attachment Device | Attaches the warmer to infusion stands (Ø 12 to 35 mm) or medical rails. |
| 7 | Appliance socket* | Electrical connection of the active insulation ASTOLINE. |
| 8 | Tube holder rear | Fixes the infusion extension at the entry point (from the liquid container). |
| 9 | Sleeve grips | To open / close the heat protection sleeve** |
| 10 | Heat exchanger (under sleeve) | Transfers heat from the internal heating element through the inserted infusion extension to the medium to be heated. |
| 11 | Tube holder front | Fixes the infusion extension at the exit point (to the patient or to ASTOLINE*). |

| # | Item | Description |
|----|---|--|
| 12 | Connector for Potential Equalization** | The purpose of additional potential equalization is to equalize potentials between different metal parts that can be touched simultaneously, or to reduce differences of potential which can occur during operation between the body, the medical electrical devices and conductive parts of other objects. The connection is made by green-yellow insulated leads (min. 4 mm ²) to standardized plug connectors and receptacles. When connecting/combining medical electrical equipment together to a medical electrical system, the requirements of IEC/EN 60601-1 must be observed. |
| 13 | Power Supply Cord with Mains Plug | Conveys electricity from the wall power supply to the device. Pull the mains plug to disconnect from supply network. |

*„S“ models only, **optional

6.4 Applied part ASTOLINE

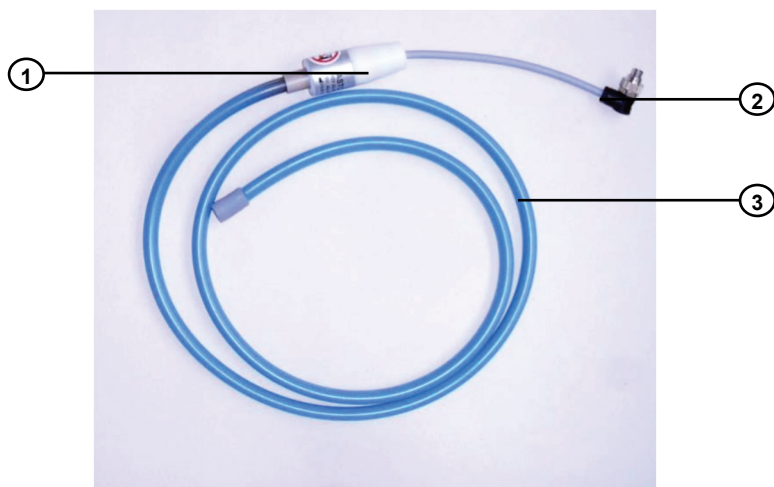

Fig. 6: Active insulation ASTOLINE*

| # | Item | Description |
|---|---------------------------------|--|
| 1 | Adapter | Connection between silicone jacket and cable |
| 2 | Appliance plug | For electrical connection of ASTOLINE* to the Warmer ASTOTHERM PLUS |
| 3 | Flexible silicone jacket | Molded groove takes the infusion extension up to a length of 130 cm and protects the heated liquid from cooling on its way from the warmer to the patient. |

*„S“ models only

6.5 Control panel

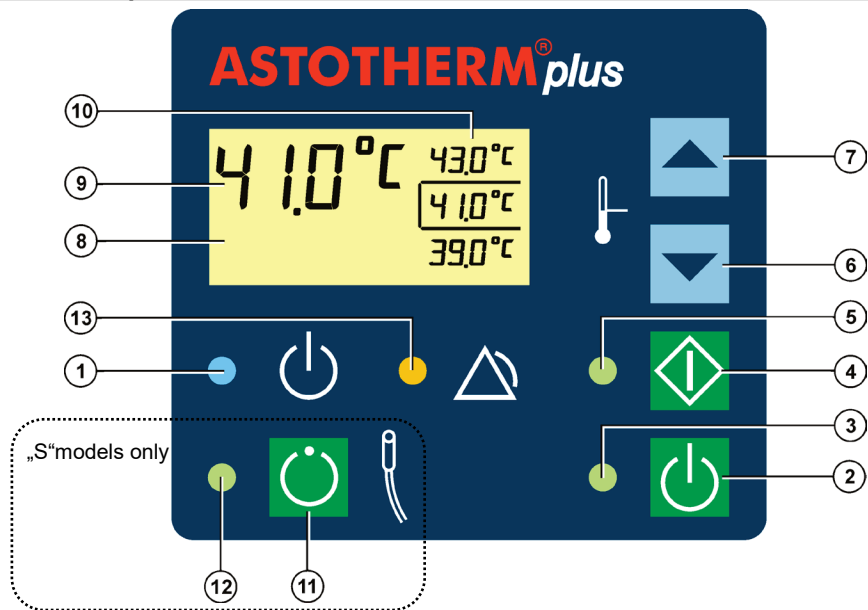

Fig. 7: Control panel

| # | Item | Description |
|---|--------------------|--|
| 1 | “Standby” LED | Illuminates blue when the warmer is in Standby Mode . |
| 2 | “Standby” button | Turns the warmer from Standby Mode to On Mode . Turns the warmer from any Mode to the Standby Mode . |
| 3 | “On” LED | Illuminates green when the warmer is in On Mode . |
| 4 | “Start” button | Starts the heating process while the device is in On Mode or Alarm Mode . Starts test 6 (see chapter 12.1 Recurrent tests), when the warmer is operated with the middle setpoint temperature. |
| 5 | “Start” LED | Flashes green when the device is in On Mode (heating is not yet started). Illuminates green when the device is in Heating Mode (“Start Button” has been pressed). |
| 6 | “Decrease” button | Selection of the next lower setpoint temperature. The frame indicates the selected temperature. Starts test 8 (see chapter 12.1 Recurrent tests), when the warmer is operated with the lowest setpoint temperature. |
| 7 | “Increase” button | Selection of the next higher setpoint temperature. The frame indicates the selected temperature. Starts test 7 (see chapter 12.1 Recurrent tests), when the warmer is operated with the highest setpoint temperature. |
| 8 | LCD Display | Informs the user about temperatures, test and fault conditions. |
| 9 | Actual Temperature | Displays the current temperature of the heat exchanger. |



| # | Item | Description |
|-----|-----------------------|---|
| 10 | Setpoint Temperatures | Shows the three possible setpoint temperatures. The frame indicates the selected temperature. |
| 11* | “ASTOLINE“ button | Switches ASTOLINE on / off when the warmer is in On Mode . |
| 12* | “ASTOLINE“ LED | Illuminates green, when ASTOLINE is switched on. |
| 13 | “Alarm“ LED | Lights yellow if an alarm condition exists. |

*„S“ models only

The following section provides further information about the operating states. This includes a description of the actions of the user and the device responses of each operating state.

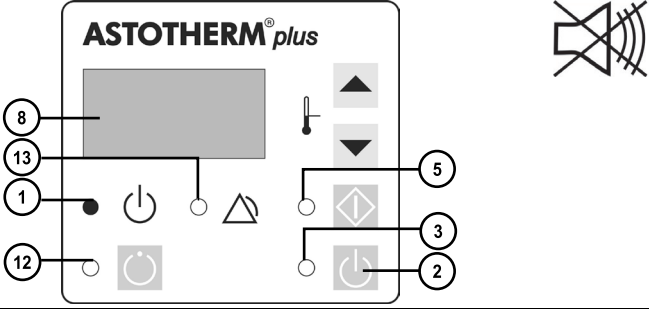
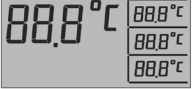

7 Operating states

7.1 Standby mode

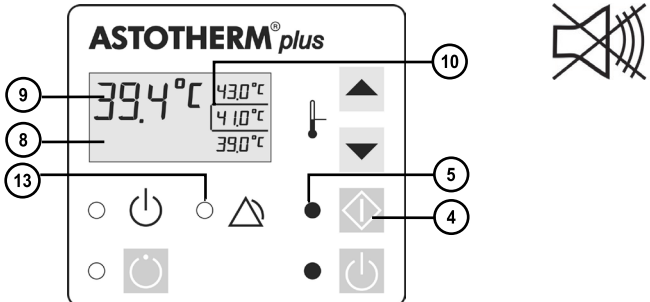

| | |
|--|---|
| Control Panel |  |
| Action | <p>When the mains cable is plugged into the socket, the device is in Standby Mode.</p> <p>Alternately, press the “Standby” button (2) to switch the device from any Mode to Standby Mode.</p> |
| Device response | <p>When plugging in the power cord briefly all segments of the display and all LEDs turn on, then</p>  <ul style="list-style-type: none"> • all segments of the display turn off (8). • “Start” LED (5), “On” LED (3), “Alarm” LED (13) and “ASTOLINE” LED* (12) turn off. • “Standby” LED (1) turns on. |
|  | <ul style="list-style-type: none"> • After a prolonged power failure (> 5 sec), the device automatically switches to Standby Mode. • In Standby Mode, only the electronic is disconnected from the power supply. The Warmer remains connected to the mains. |

*„S“ models only

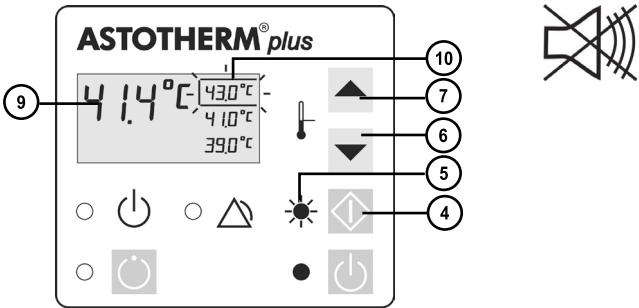

| 7.2 On mode | |
|-----------------|--|
| Control Panel | |
| Action | Press the “Standby” button (2) to switch the device from Standby Mode to On Mode . |
| Device response | <ul style="list-style-type: none"> • “Standby” LED (1) turns off. • “On” LED (3) turns on. • The backlight of the display (8) lights up. • The display (8) shows the current temperature (9) (eg. 22.4°C) of the heat exchanger and the available range of setpoint temperatures (10). The selection frame is flashing. • “Start” LED (5) flashes. • „Alarm” LED (13) lights • Acoustic alarm signal beeps. |
| | As long as the temperature of the heat exchanger is below 15°C, the display shows “- - -”. |

| 7.3 Heating mode | |
|---|--|
| Control Panel |  |
| Action | <p>Press the “Start” button (4) at least for one second to switch the warmer from On Mode to Heating Mode.</p> |
| Device response | <ul style="list-style-type: none"> • While the button is pressed, a self-test is performed. During this test the safety cut offs are activated to verify their safe function. The brief clicking of the relay can be heard. • “Start” LED (5) turns on. • Acoustic alarm signal stops. • The heater is activated until the setpoint temperature (10) (indicated by the frame) is reached. • The display (8) shows the increasing current temperature (9) of the heat exchanger (e.g. 39.4°C). • “Alarm” LED (13) lights until the setpoint temperature has exceeded (during heating up) the tripping limit of the Low Temperature Alarm (see chapter 10.1 Low temperature alarm). |
|  | <ul style="list-style-type: none"> • If the “Start” button “(4)” is not pressed long enough, the self-test cannot be completed and the warmer will not start. Then repeat the procedure and press the “Start” button (4) for <u>at least</u> one second. • After a short power failure (< 5 seconds), and after return of the power supply, the warmer resumes operation again to the setpoint temperature which was previously selected. |

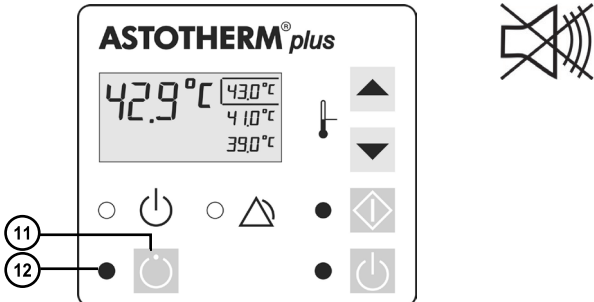

7.4 Increasing/Decreasing the setpoint temperature

| | |
|---|--|
| Control Panel |  |
| Action | <ol style="list-style-type: none"> Briefly press the “Increase” button (7) or “Decrease” button (6), while the device is turned on (On Mode) or started (Heating Mode) to change the setpoint temperature within the three indicated temperatures. Confirm the new setpoint temperature within 5 seconds by pressing the “Start” button (4). |
| Device response | <ul style="list-style-type: none"> The flashing frame indicates the selected setpoint temperature (10). “Start” LED (5) flashes green until to the confirmation with the “Start” button (4). After confirmation the “Start” LED (5) lights green and the frame marks the currently selected setpoint temperature (10). The displayed actual temperature (9) rises or falls according to the selection. |
|  | <ul style="list-style-type: none"> If the newly selected setpoint temperature is not confirmed within 5 seconds by pressing the “Start” button (4), the temperature regulation continues working with the initial setpoint temperature. During operation, the mean temperature of the heat exchanger is displayed; this is not equal to the temperature of the medium to be warmed. ASTOTHERM PLUS neither regulates nor monitors/displays the current temperature of the medium to be warmed. |

7.5 ASTOLINE* On mode

| | |
|---|---|
| Control Panel |  |
| Action | Briefly press the “ASTOLINE” button (11) while the device is in On Mode or Heating Mode . |
| Device response | <ul style="list-style-type: none"> • “ASTOLINE” LED (12) turns on green. • The active insulation ASTOLINE slowly warms up. |
|  | <p>If no heat is taken away from the Warmer (e.g. at high ambient temperature and stagnant liquid or low flow or when lowering the setpoint temperature) the heating element of ASTOLINE is switched off automatically after appr. 4.5 minutes, and ASTOLINE cools down.</p> <p>The “ASTOLINE” LED (12) continues lighting. With recurrent heat demand ASTOLINE is reconnected automatically.</p> |

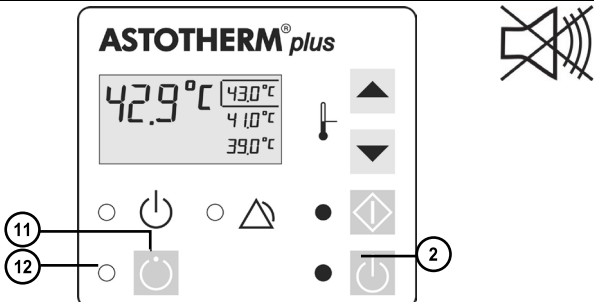
7.6 ASTOLINE* Off mode

| | |
|---|---|
| Control Panel |  |
| Action | Briefly press the “ASTOLINE” button (11) while the device is in ASTOLINE On Mode . |
| Device response | <ul style="list-style-type: none"> • “ASTOLINE” LED (12) turns off. • The active insulation ASTOLINE cools down slowly. |
|  | Turning off the Warmer with the “Standby” button (2) automatically causes the shutdown of ASTOLINE. |

*„S“ models only

8 Installation

8.1 Initial start-up

Prior to first use, perform the following inspections:

- Visual Inspection (s. **chapter 12.1 Recurrent tests**)
- Check the mains voltage (compare the details on the type label with the available mains voltage.) An incorrect mains voltage may destroy the equipment.

National regulations may require different inspections for the initial start-up. If additional tests are required for electrical safety, these must be carried out according to **chapter 12.1 Recurrent tests, 12.2 Set up for electrical tests and 12.3 Test protocol.**

8.2 Installation of the warmer

For safe installation, the warmer is equipped with a universal attachment device. With this, the device can be securely attached to infusion stands as well as to medical standard rails.

8.2.1 Attachment to infusion stands/rods

1. Turn the handwheel counterclockwise to open the attachment device.
2. Select a maximum height of 165 cm (ASTOSTAND: 180 cm) at the infusion stand and place the open clamping area of the attachment device on the infusion stand.
3. Turn the handwheel clockwise to lock the attachment device to the infusion stand.
4. Check that the warmer is firmly fixed.

8.2.2 Attachment to medical rails

1. Unscrew the small knurled screw on the bottom of the attachment device.
2. Hang the warmer obliquely from above with the attachment device into the standard rail.
3. Fix the heater by tightening the small knurled screw to the standard rail.
4. Check that the warmer is firmly fixed.

9 Getting started

Getting started is grouped into 4 sections. Read through each section before performing a procedure.



Risk of injury!

Use only approved infusion sets / infusion extensions.

ASTOTUBE is the original CE-marked accessory for ASTOTHERM PLUS.

| ASTOTUBE Order No. | Description | Suitable for model |
|--------------------|--|--------------------|
| IFT 30460 | Sterile infusion extension made from PVC, outer diameter Ø 4 mm, length 575 cm. Filling volume approx. 40 ml | AP220 |
| | | AP220S |
| IFT 30410 | Sterile infusion extension made from PVC, outer diameter Ø 6.8 mm, length 490 cm. Filling volume approx. 89 ml | AP260 |
| | | AP260S |



- To achieve the greatest possible benefit, ASTOTHERM PLUS should be set up close enough to the patient so that the end of the active insulation ASTOLINE* reaches up to the point of injection.
- ASTOTHERM PLUS and ASTOLINE* should be switched on before use so that ASTOLINE* has time to heat up.
- Do not position the device in a manner that is difficult to disconnect it from mains by the mains plug.

*„S“ models only

9.1 Preparation for use



Risk of injury!

Do not use the ASTOTHERM PLUS until the following error conditions have been remedied through appropriate corrective action:

- Damaged or worn cables, plugs, or connecting socket.
- Damaged housing, damaged or loose control panel.
- Device has been exposed to mechanical impact / exposed to severe shock or exposed to liquid.
- Alarm without knowing the cause.
- Damaged ASTOLINE („S“-models only), e.g. caused by clamps, scissors or improper handling or storage.
- Damaged or missing markings/safety signs/warnings on the warmer and/or ASTOLINE.

WARNING





Risk of injury!

- Use of the ASTOTHERM PLUS must be carried out under the supervision of a physician.
- The mains cable should not touch the patient and should not hinder the treating personnel.

CAUTION

Risk of injury!



When fixing the Warmer to a mounting device (e.g. IV pole) pay attention to the max. safe working load and tipping stability. Using normal infusion stands ASTOTHERM PLUS may be mounted at a height of up to 165 cm. If you use the robust IV pole ASTOSTAND, the device can be mounted up to 180 cm.



1. Attach ASTOTHERM PLUS to an IV pole or to a medical standard rail using the attachment device according to **chapter 8.2 Installation of the warmer**.
2. Plug the mains plug into a socket.
 - The blue “Standby” LED  turns on, the device is in **Standby Mode**.
3. Press the “Standby” button  to switch ASTOTHERM PLUS to **On Mode**.
 - The blue “Standby” LED turns off and the green “On” LED  turns on.
4. Check the audible and visual indicators and the display:
 - The acoustic alarm signal beeps and the “Alarm” LED  lights yellow.
 - The „Start” LED  flashes green and the display shows the actual temperature of the heat exchanger and the available setpoint temperatures.

WARNING

Risk of injury!

If the yellow “Alarm” LED and the acoustic alarm are not activated automatically when the device turns on by pressing the “Standby” button, remove the device from service immediately.

5. Press the “Increase” button  or the “Decrease” button  to select a different setpoint temperature, if necessary.

6. Press the “Start” button  for at least one second to switch ASTOTHERM PLUS to **Heating Mode**.
- While the button is pressed, the clicking of the self-test can be heard.
 - The “Start” LED  illuminates green.

| | |
|--|--|
|  | <ul style="list-style-type: none"> • Any change of the setpoint temperature must be confirmed within 5 seconds by pressing the „Start” button, otherwise the warmer uses the previously selected setpoint temperature. • As long as the temperature of the heat exchanger is below 15°C, the display shows “- - -”. • As long as the actual temperature is below the trigger temperature of the low temperature alarm (4°C lower than the selected setpoint temperature), the “Alarm” LED lights yellow. • The setpoint temperature can be changed during operation at any time following chapter 7.4 Increasing/Decreasing the setpoint temperature. |
|--|--|

Only for „S“ models:



7. Connect the plug of ASTOLINE to the appliance socket on the rear housing part (the correct alignment is marked with arrows, s. fig 8).
8. Press the “ASTOLINE” button   to switch on ASTOLINE.
- The “ASTOLINE” LED illuminates green and ASTOLINE heats up slowly.



Fig. 8: Connection of ASTOLINE

NOTICE

- Only the active insulation ASTOLINE must be connected to the appliance socket of the „S“ models.
- Do not rotate the angled connector housing of ASTOLINE in the inserted state. This can cause damage to appliance plug and/or socket.

9.2 Inserting the infusion line, priming and starting the infusion

WARNING

Risk of air embolism!

- Be aware of the potential for air emboli when using a blood and fluid warmer.
- Therefore prime all filters, lines and disposable sets before starting a treatment.
- Make sure all connections of the complete fluid stream are fixed tightly to prevent fluid leakages and inadvertent infusion of air into the fluid stream.
- When fluids are warmed up, it is possible that gas may evolve (bubble form).
- Do not warm infusions containing soluted gas (e.g. bicarbonate).
- Extreme care should always be taken to ensure that a bolus of air does not pass to the patient.

WARNING

Risk of infection!

Use aseptic procedures.

WARNING

Risk of haemolysis!

Make sure that the infusion line is not kinked.

CAUTION

Risk of hypothermia!

- When ASTOTHERM PLUS is used, the patient's body temperature must be monitored at regular intervals.
- The specified heating performance will only be achieved by inserting the infusion extension into the entire heat exchanger and, if applicable, in the entire length of ASTOLINE.
- The temperature control of the ASTOTHERM PLUS controls and monitors the current temperature of the heat exchanger, but not the patient's body temperature.
- If the ASTOTHERM PLUS cannot be started or if the patient's temperature balance is insufficient, consider the use of alternative warming methods in order to avoid or reduce hypothermia or to improve the patient's well-being.



Pressure losses can occur when infusion extensions are used (depending on tube dimensions and flow rate).

1. Detach the heat protection sleeve (optional) by gently pulling apart the two grips.

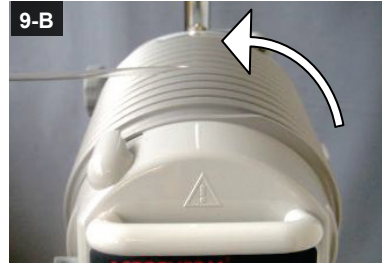

Fig. 9: Inserting the infusion extension (start)

2. Clip the IV end of the infusion extension (female Luer Lock) into the rear tube holder (fig. 9-A).
3. Starting from the back, wind and insert the infusion extension in a counter clockwise direction up and around into the circumferential groove of the heat exchanger (fig. 9-B). Gently pulling makes it easier to insert and improves the seating of the infusion extension.



Fig. 9: Inserting of the infusion extension (continuation)

4. After leaving the last circulation, clip the infusion extension into the front tube holder (fig. 9-C).

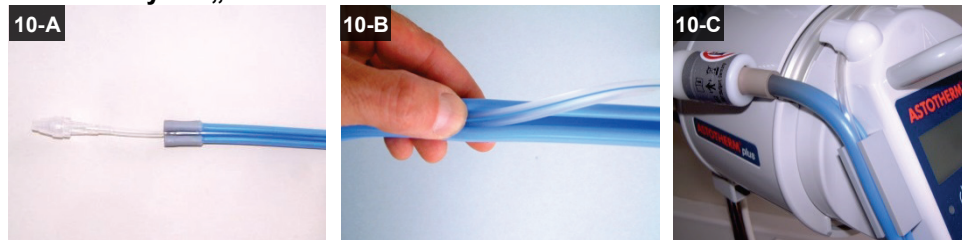
Additionally for „S“ models:**Fig. 10: The use of ASTOLINE**

5. Starting from the patient side, place the end of the infusion extension with 3 to 5 cm overlap into ASTOLINE (fig. 10-A) and insert it with the thumb into the groove of ASTOLINE (fig. 10-B).
6. Clip ASTOLINE together with the inserted infusion extension into the bracket (fig. 10-C).

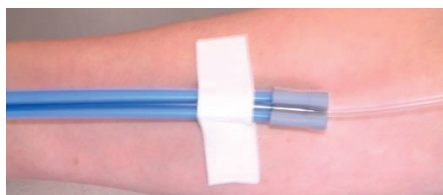

To facilitate insertion of the infusion extension into ASTOLINE, ASTOLINE can be dusted with usual in trade powder or talcum powder.

**Fig. 11: Fixing of ASTOLINE**

7. Check the correct position of the infusion extension:
 - a. Infusion extension is fully in the groove
 - b. Infusion extension „skips“ no circulation
 - c. Infusion extension is not kinked or twisted in itself
8. Connect the infusion extension with infusion set of the liquid container.
9. Prime the infusion system: allow fluid to flow until no air is observed in the infusion lines and the lines are completely filled with fluid.
10. Place the heat protection sleeve (optional) around the heat exchanger, align the grips upwards and let the latches snap into place by squeezing.
11. Connect the patient side end of the infusion extension to the patient cannula and ensure a good fixation (e.g. with tape), especially when ASTOLINE is used (fig. 11).



Fig. 12: ASTOTHERM PLUS prepared with ASTOLINE and heat protection sleeve



Fig. 13: ASTOTHERM PLUS prepared (without ASTOLINE and without heat protection sleeve)

The infusion extension is now free hanging with ASTOLINE (fig. 12) or without ASTOLINE (fig.13) between the patient and ASTOTHERM PLUS and the treatment can be started.

! WARNING

Risk of overheating!



- ASTOLINE („S“-models only) must hang freely while in use. Do not kink, cover (not even partially), clamp (for example, with a surgical clamp) or roll ASTOLINE.
- Do not place ASTOLINE under or directly beside the patient. Heat build-up can occur and/or the infusion extension can be squeezed off.

! CAUTION

Risk of needle dislodgement!

The weight of ASTOLINE („S“-models only) pulls on the patient's infusion line. Carefully secure the patient's access against pulling. Attach the ASTOLINE by suitable methods (e.g. tape, plaster or Velcro®).

9.3 After use

1. Discontinue infusion.
2. Press the “Standby” button  for one second to switch off ASTOTHERM PLUS and ASTOLINE („S“ models only).
 - All indicators turn off, the LED “Standby”  turns on blue.



To disconnect ASTOTHERM PLUS from the mains, it is necessary to completely pull out the plug.

3. Disconnect the infusion extension from the cannula.

Only for „S“ models:

4. Pull the infusion line out of the ASTOLINE heating profile.



ASTOLINE does not have to be disconnected from its socket after use. When not in use, ASTOLINE can be hung around the back of the device.

NOTICE

- If ASTOLINE is disconnected from ASTOTHERM PLUS, the appliance socket should be covered with the protective cap. This prevents the contacts to become polluted.
- To avoid damaging during storage, place ASTOLINE loosely around the warmer and do not kink or clamp it. Use narrow plaster strips or other narrow, soft fixation methods (for example cannula fixation, tube holder or Velcro®) to fix ASTOLINE.

5. Detach the heat protection sleeve (optional).
6. Wrap the infusion extension out from the circumferential groove of the heat exchanger.
7. Clean and disinfect ASTOTHERM PLUS and ASTOLINE after each treatment and if required.

9.4 Cleaning and disinfecting

NOTICE

To avoid damage to the warmer and ASTOLINE:

- Do not immerse the warmer or ASTOLINE in liquid.
- Do not disinfect the warmer with these methods:
 - steam (autoclave)
 - hot air
 - thermo-chemical cleaning solutions.
- Refer to the specific instructions for use of the disinfectants.

CAUTION

Risk of injury!

Damage to ASTOLINE can cause overheating, therefore follow the instructions below:

- Only disinfect ASTOLINE with alcohol-based agents or an approved disinfectant.
- Do not use solutions containing hypochlorite (bleach) for disinfecting ASTOLINE.
- Do not kink or pull excessively ASTOLINE.
- Do not use any clamps or sharp instruments on ASTOLINE as damage to ASTOLINE or the infusion line inside may result.
- Use narrow plaster strips or other narrow, soft fixation methods (for example cannula fixation, tube holder or Velcro®) to fix ASTOLINE.
- Do not use cleaning and disinfection procedures which differ from the procedure described.

ASTOTHERM PLUS

Clean and wipe-disinfect ASTOTHERM PLUS in accordance with the procedure below:

1. Disconnect the mains plug from the socket.
2. Clean all surfaces with a soft cloth/cotton swab and mild soap-and-water solution.
3. Disinfect **ASTOTHERM PLUS** with either:
 - An approved disinfectant
 - An alcohol-based disinfectant with a low content of aldehydes (< 0.2%)
 - A mild bleach solution (max. 0.25 % hypochlorite)

ASTOLINE

Clean and wipe-disinfect ASTOLINE in accordance with the procedure below:

1. Clean all surfaces of the heating profile including the groove with a soft cloth/ cotton swab and a mild soap-and-water solution or with water only.
2. Disinfect the **ASTOLINE** only with approved disinfectants or with disinfectants based on alcohol with a low content of aldehyds (< 0.2 %).

Do not disinfect ASTOLINE with disinfectants containing hypochlorite (bleach).

In doing so follow the contact time of the disinfectant given in the specific instructions for use of the disinfectant! After this time dry ASTOLINE.

3. Residuals of disinfectants cause a sticky surface, it is strongly recommended to rinse with water after about 5 disinfections or once a week.



To facilitate insertion of the infusion extension, ASTOLINE can be dusted with usual in trade powder or talcum powder.

List of approved disinfectants*:

| | |
|--------------------------------------|--|
| • Melisepto [®] | • Clinell Alcohol Wipes |
| • Biguamed [®] Perfekt N | • Incidin [®] Plus |
| • Mikrozyd [®] Liquid | • HyPro medical 3% H ₂ O ₂ |
| • Bacillo [®] Plus | • Aniosurf |
| • Mikrobac [®] forte | • Oxivir Tb |
| • ClearSurf [®] | • Diosol 3% H ₂ O ₂ PURE |
| • Clinell Universal Sanitising Wipes | • Virox5 RTU |

*In the United States please use only disinfectants which are registered by EPA (U.S. Environmental Protection Agency) or cleared by FDA (U.S. Food and Drug Administration).

10 Alarms and troubleshooting

In the event of device failure, two independent monitoring systems ensure the safety against overheating. Except for the low temperature alarm, all alarms switch off immediately the heating function. Thus, the overheating of the heated liquid is surely prevented.

ASTOTHERM PLUS does not require continuous supervision by the operator, but it must be checked at regular intervals (depending on the condition of the patient status). Then the intended operator's position is directly in front of the control panel.

In case of failure of the equipment, possible injury to the patient is delayed and the operator has sufficient time to provide alternative warming methods.



According to IEC/EN 60601-1-8 the alarms are defined as "**Low Priority Alarms**".

The alarms are only triggered by technical alarm conditions (equipment faults). The alarm signal is given visually and acoustically.

| Alarm signal | Characteristics |
|---------------------|------------------------------|
| visible | yellow LED lights constantly |
| audible | Sound pulse, all 17 sec. |

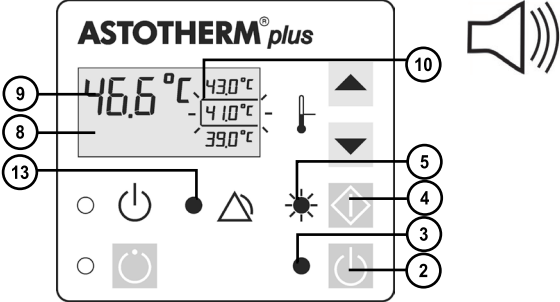

| 10.1 Low temperature alarm | |
|--|---|
| Control panel | |
| Device response | <ul style="list-style-type: none"> • The display (8) shows an actual temperature (9), which is more than 4°C below the setpoint temperature (10). • The green “On” LED (3) lights. • The green “Start” LED (5) lights. • The “Alarm” LED (13) lights yellow. • The acoustic alarm signal is activated with a 2 minute delay. • The heating element is not switched off. |
| Alarm condition | The current temperature of the heat exchanger is more than 4°C below the setpoint temperature during Heating Mode . |
| Possible reason(s) ► Required action(s) | <p>Inlet temperature of the liquid is too low and the flow rate is too high.</p> <p>► Reduce flow rate.</p> <p>Warmer is defective.</p> <p>► Return ASTOTHERM PLUS to local sales office.</p> |
| Possible actions to clear | None, the alarm is automatically disabled if the alarm condition is eliminated. |
| | During warm up phase, as long as the actual temperature is 4°C below the selected setpoint temperature, low temperature alarm is displayed (visual alarm signal only). |

10.2 Overheating alarm

| | |
|---|---|
| Control panel |  |
| Device response | <ul style="list-style-type: none"> • The display ⑧ shows the current temperature ⑨, which drops slowly after the alarm was activated. • The selection frame ⑩ flashes. • The green “On” LED ③ lights. • The “Start” LED ⑤ flashes green. • The “Alarm” LED ⑬ lights yellow. • The acoustic alarm signal sounds every 17 seconds. • The heating element is switched off. • ASTOLINE („S“-models only) is switched off. |
| Alarm condition | The temperature of the heat exchanger rises to the alarm limit of 45.5°C ± 1.0°C . |
| Possible reason(s) ► Required action(s) | <p>Effect of external heat source, such as sunlight or radiator. ► Eliminate the heat source and/or select cooler location.</p> <p>Ambient temperature too high. ► Eliminate heat source and/or select cooler location.</p> <p>Warmer is defective. ► Return ASTOTHERM PLUS to local sales office.</p> |
| Possible actions to clear | <p>Press the “Start” button“ ④ to switch the device back to Heating Mode (after cooling down).</p> <p>Press the “Standby” button“ ② to switch the device to Standby Mode.</p> |
|  | <ul style="list-style-type: none"> • As long as the actual temperature ⑨ is above the alarm limit, the warmer cannot be switched to the Heating Mode. • In order to prevent potential overheating due to a possible failure of the temperature control system, the ASTOTHERM PLUS possesses two independent excessive temperature cut offs. |

| 10.3 Cable break alarm | |
|---|--|
| Control panel | |
| Device response | <ul style="list-style-type: none"> • The display ⑧ shows „---“. • The selection frame ⑩ flashes. • The green “On” LED ③ lights. • The “Start” LED ⑤ flashes green. • The “Alarm” LED ⑬ lights yellow. • The acoustic alarm signal sounds every 17 seconds. • The heating element is switched off. |
| Alarm condition | A defect of the cable break detection or a temperature sensor break has been detected. |
| Possible reason(s) ►Required action(s) | Warmer is defective. ►Return ASTOTHERM PLUS to local sales office. |
| Possible actions to clear | Press the “Standby” button ② to switch the device to Standby Mode . |

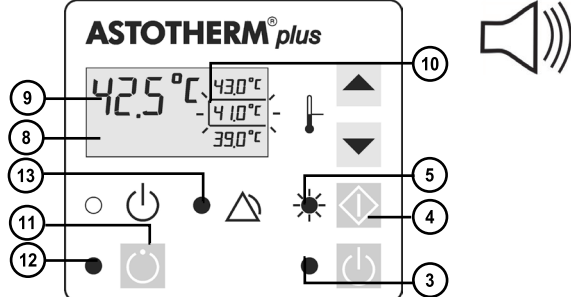
10.4 ASTOLINE alarm ("S" models only)

| | |
|---|---|
| Control panel |  |
| Device response | <ul style="list-style-type: none"> • The display (8) shows the current temperature (9), which drops slowly after the alarm was activated. • The selection frame (10) flashes. • The green "On" LED (3) lights. • The green "ASTOLINE" LED (12) lights. • The "Start" LED (5) flashes green. • The "Alarm" LED (13) lights yellow. • The acoustic alarm signal sounds every 17 seconds. • The heating element is switched off. |
| Alarm condition | The power supply of ASTOLINE is open or shorted. |
| Possible reason(s) ► Required action(s) | <p>ASTOLINE is not connected and it was tried to switch on ASTOLINE with the "ASTOLINE" button (11).</p> <p>► Connect ASTOLINE and repeat procedure.</p> <p>ASTOLINE is defective.</p> <p>► Return ASTOLINE to local sales office.</p> |
| Possible actions to clear | <ol style="list-style-type: none"> 1. Press the "ASTOLINE" button (11) to switch off ASTOLINE. 2. Press the "Start" button (4) to switch the device to Heating Mode. |
|  | In the case of a defective ASTOLINE, ASTOTHERM PLUS can be used with deactivated ASTOLINE. |

| 10.5 Processor alarm | |
|---------------------------|--|
| Control panel | |
| Device response | <p>Even when you plug in the power cord</p> <ul style="list-style-type: none"> • the “Alarm” LED (13) lights yellow. • the acoustic alarm signal sounds every 17 seconds. • none of the buttons can cause a device reaction. |
| Alarm condition | Program fault |
| Possible reason(s) | Temporary program fault ▶ Alarm reset (see below) |
| ▶ Required action(s) | Permanent program fault caused by defect data file. ▶ Return ASTOTHERM PLUS to local sales office. |
| Possible actions to clear | <ol style="list-style-type: none"> 1. Press the “Increase” button (7) and the “Decrease” button (6) at the same time until the device switches to Standby Mode. 2. Unplug the power cord and wait one minute. 3. Plug in again the power cord. |

10.6 Standby mode - failure

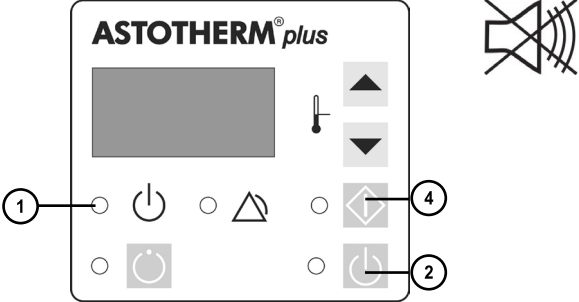
| | |
|--|--|
| Control panel |  |
| Device response | <p>The “Standby” LED ① is off and the device cannot be switched to On Mode by pressing the “Standby” button ②.</p> |
| Possible reason(s) ► Required action(s) | <p>Power supply problem or no power. ► Check plugs and fuses compare mains voltage with rating plate.</p> <p>Warmer not plugged in. ► 1. Plug the warmer into functioning socket. 2. Press the “Standby” button ② . 3. Press then the “Start” button ④ to switch the device to Heating Mode.</p> <p>Warmer is defective. ► Return ASTOTHERM PLUS to local sales office.</p> |

11 Brief overview of operating states and alarms

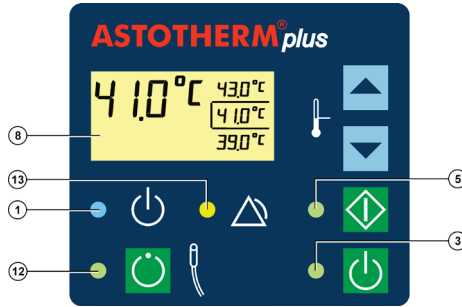

| 11.1 Overview of operating states | | | | | | | | |
|-----------------------------------|----------------|---------------|----------------|-------------|-------------|-----------|-----------------------|---|
| Operating state | Display (8) | "Standby" LED | "ASTOLINE" LED | "Alarm" LED | "Start" LED | "On" LED | Acoustic alarm signal | Possible reason(s) |
| | | blue (1) | green (12) | yellow (13) | green (5) | green (3) | | |
| Standby Mode | OFF | ● | ○ | ○ | ○ | ○ | | - |
| On Mode | --- | ○ | ○ | ● | | ● | | $T_{Act} \leq 15^{\circ}C$ or $T_{Act} \geq 50^{\circ}C$ |
| | T_{Act} | ○ | ○ | ● | | ● | | - |
| Heating Mode | --- | ○ | ○ or ● | ● | ● | ● | | $T_{Act} \leq 15^{\circ}C$ |
| | T_{Act} | ○ | ○ or ● | ○ | ● | ● | | - |
| | T_{Act} | ○ | ○ | ● | | ● | | „Start“ button has been pressed too short. Otherwise device defect. |
| | T_{Act} | ○ | ● | ● | | ● | | Defective ASTOLINE or not connected |

T_{Act} = Actual Temperature (current temperature of heat exchanger)
 T_{set} = Setpoint Temperature (selected temperature, marked by a frame)

○ = LED is off ● = LED lights = LED flashes

| 11.2 Overview of alarms | | | | | | | | |
|---|------------------------------------|---------------|----------------|-------------|-------------|------------|---|--|
| Alarm | Display ⑧ | "Standby" LED | "ASTOLINE" LED | "Alarm" LED | "Start" LED | "On" LED | Acoustic alarm signal | Possible reason(s) |
| | | ① blue | ⑫ green | ⑬ yellow | ⑤ green | ③ green | | |
| Low Temperature Alarm | T_{act} | ○ | ○ or ● | ● | ● | ● | sounds every 2 min. | Low temperature ($T_{act} \leq T_{set} - 4^\circ\text{C}$) because of cold liquid/high flow rate or device defective |
| Excessive Temperature Alarm | T_{act} | ○ | ○ or ● | ● | | ● | | $T_{act} > 45.5^\circ\text{C} \pm 1^\circ\text{C}$ |
| Cable Break Alarm | --- | ○ | ○ or ● | ● | | ● | | Temperature sensor(s) or associated circuit(s) interrupted |
| ASTOLINE Alarm | T_{act} | ○ | ● | ● | | ● | | Defective ASTOLINE or not connected |
| Processor Alarm | OFF | ○ | ○ | ● | ○ | ○ | | Program failure |
| Manual Excessive Temperature Alarm Test 1 | $E1$ alternating with T_{act} | ○ | ○ | ● | | ● | | "Start" button has been pressed for longer than 3 seconds |
| Manual Excessive Temperature Alarm Test 2 | $E2$ alternating with T_{act} | ○ | ○ | ● | | ● | | "Increase" button has been pressed for longer than 3 seconds |
| Manual Low Temperature Alarm Test 3 | $E3$ Alternating with T_{act} | ○ | ○ | ● | ● | ● | after cooling to $T_{act} \leq T_{set} - 4^\circ\text{C}$ | "Decrease" button has been pressed for longer than 3 seconds |

T_{act} = Actual Temperature (current temperature of heat exchanger)
 T_{set} = Setpoint Temperature (selected temperature, marked by a frame)

○ = LED is off

● = LED lights

= LED flashes

12 Maintenance

ASTOTHERM PLUS does not require preventive maintenance (e.g. replacement of liquids or components). Recurrent tests shall be performed according to chapter 12.1.



No service or maintenance shall be carried out while in use with a patient.

WARNING

- **Risk of injury!**

- The service personnel must be appropriately trained and qualified.
- The ASTOTHERM PLUS does not contain any parts the user can repair. Therefore, do not attempt to repair the ASTOTHERM PLUS yourself. Contact your local sales point.
- Any repairs (such as, but not limited to, changing the power supply cord) to the equipment may only be carried out by persons authorised and qualified by the manufacturer.
- Modifications to the device are not permitted.

The accessories specified in **chapter 15 Ordering information, accessories and consumables** may be replaced without restriction by the operating or maintenance personnel.

On request, STIHLER ELECTRONIC GmbH will provide service instructions that will allow properly trained and qualified persons to repair the parts of the equipment that the manufacturer has designated as repairable.

Provision of technical documents and/or spare parts is not an authorisation from the manufacturer to open or repair the equipment.

12.1 Recurrent tests

12.1.1 Warmer **ASTOTHERM PLUS** (ASTOLINE see 12.1.2)

A recurrent test must be carried out on the ASTOTHERM PLUS warmer at least every 24 months to ensure the safe operation of the warmer.

Please ensure that all the applicable national directives (e.g. IEC/EN 62353) for checking the safety of medical equipment are observed additionally and that the test equipment is calibrated.

Necessary test equipment:

- Standard medical electrical safety tester
- Digital clinical thermometer (max. diameter of probe tip 3.5 mm and accuracy $\pm 0.1^{\circ}\text{C}$)

The following sections describe how the tests are to be performed. The attached test protocol (see **chapter 12.3 Test protocol**) can be used.







| Test 1 | Visual inspection |
|------------------|--|
| Required Actions | Check the following items: <ul style="list-style-type: none"> • Complete and legible labeling. • No damage to the housing. • Control panel in good condition. (Since the front foil prevents fluid from entering the unit, it is important that its full surface adheres securely to the housing.) • No defects in the power supply cord and mains connector insulation, with clean and non-corroded contacts. |
| Test 2 | Protective earth resistance |
| Required Actions | Measure the resistance between the earth pin on the power plug and the connector for potential equalization, located on the rear side of the housing. For detailed information performing this test see chapter 12.2 Set up for electrical tests . |
| Result | The test is successful when the limits are met in accordance with the test protocol. |
| Test 3 | Insulation resistance |
| Required Actions | Measure the resistance of the insulation between the live parts and the parts which are connected to earth. For detailed information performing this test see chapter 12.2 Set up for electrical tests . |
| Result | The test is successful when the limits are met in accordance with the test protocol. |



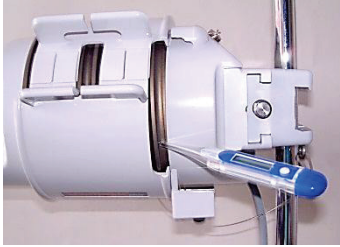



| | |
|---|--|
| Test 4.1 Optional to test 4.2 | Equipment leakage current (alternative method) |
| Required Actions | Measure the current flowing from protective earthed conductor to the two (shorted) power supply connections. For detailed information performing this test see chapter 12.2 Set up for electrical tests. |
| Result | The test is successful when the limits are met in accordance with the test protocol. |







or alternatively:





| | |
|---|--|
| Test 4.2 Optional to test 4.1 | Earth leakage current (direct method) |
| Required Actions | Measure the maximum earth leakage current (PE open)*. Measure all combinations of line polarity with neutral open (single fault condition) and closed (normal condition). For detailed information performing this test see chapter 12.2 Set up for electrical tests. |
| Result | The test is successful when the limits are met in accordance with the test protocol. |





*is usually done automatically by the safety tester

| Test 5 | Temperature control and display |
|---|---|
| Required Actions | <ol style="list-style-type: none"> 1. Insert the clinical thermometer into the rear measuring bore on the side of the heat exchanger.  <p style="text-align: center;">Fig. 14: Temperature</p> <ol style="list-style-type: none"> 2. Plug the mains plug into a socket. 3. Press the “Standby” button  (On Mode). 4. Select a temperature of maximum 41°C (if necessary press the “Decrease” button  or the „Increase” button . 5. Press the “Start” button  for at least one second (Heating Mode). 6. Wait about 5 minutes until the actual temperature is equal to the setpoint temperature. 7. Start the measurement on the clinical thermometer and measure the actual temperature of the heat exchanger. 8. Compare the measured temperature with the displayed temperature and the selected setpoint temperature of the Warmer. |
| Result | The test is successful when the limits are met in accordance with the test protocol (chapter 12.3 Test protocol) |
|  | <ul style="list-style-type: none"> • This test is used to check the essential performance. • Absolutely avoid during this measurement influences from the environment (drafts, heat radiation of other heat sources, etc). Use if available the heat protection sleeve (slightly rotated so that the measuring bore is freely accessible). • Clinical thermometers are designed as „immersion sensors“. In order to achieve a sufficiently accurate measurement result, the thermometer must be immersed deep enough (depending on manufacturer and type). Because here only the metal tip of the thermometer is used, usually the measured temperature is slightly lower than the real temperature. |

| Test 6 | Manual excessive temperature cut off 1 |
|---|---|
| Required Actions | 1. Operate the Warmer with the middle setpoint temperature. 2. Hold down the “Start” button  at least for 3 seconds, to start the test. |
| Result | <p>The test is successful, when:</p> <ul style="list-style-type: none"> • The display alternately indicates t1 and the actual temperature and after a short time <ul style="list-style-type: none"> - the “Start” LED  flashes green, - the “Alarm” LED  lights yellow, - the acoustic alarm signal sounds. <p>The test is <u>not</u> successful if any of the following conditions occurs:</p> <ul style="list-style-type: none"> • The display does not indicate t1. • The “Start” LED  does not flash. • The “Alarm” LED  does not light. • The acoustic alarm does not beep. |
|  | For the continuation of the tests, press the “Start” button  to switch the Warmer back to the Heating Mode . |



| Test 7 | Manual excessive temperature cut off 2 |
|---|---|
| Required Actions | 1. Operate the Warmer with the highest setpoint temperature. 2. Hold down the “Increase” button  at least for 3 seconds, to start the test. |
| Result | <p>The test is successful, when:</p> <ul style="list-style-type: none"> • The display alternately indicates t2 and the actual temperature and after a short time <ul style="list-style-type: none"> - the “Start” LED  flashes green, - the “Alarm” LED  lights yellow, - the acoustic alarm signal sounds. <p>The test is <u>not</u> successful if any of the following conditions occurs:</p> <ul style="list-style-type: none"> • The display does not indicate t2. • The “Start” LED  does not flash. • The “Alarm” LED  does not light. • The acoustic alarm does not beep. |
|  | For the continuation of the tests, press the “Start” button  to switch the Warmer back to the Heating Mode . |

| Test 8 | Manual low temperature alarm |
|---|---|
| Required Actions | 1. Operate the Warmer with the lowest setpoint temperature. 2. Hold down the “Decrease” button  at least for 3 seconds, to start the test. |
| Result | <p>The test is successful, when:</p> <ul style="list-style-type: none"> • The display alternately indicates t3 and the actual temperature. • The actual temperature slowly decreases, and after cooling to $T_{Act} = T_{Set} - 4^{\circ}C$ <ul style="list-style-type: none"> - the “Alarm” LED  lights yellow and - after another 2 minutes, the acoustic alarm signal sounds. <p>The test is <u>not</u> successful if any of the following conditions occurs:</p> <ul style="list-style-type: none"> • The display does not indicate t3. • The “Alarm” LED  does not light after cooling. • The acoustic alarm signal does not beep after another 2 minutes waiting time. |
|  | <ul style="list-style-type: none"> • Without heat protection sleeve the Warmer cools down faster in this test. • The cooling time depends in the initial temperature and the ambient temperature. • To exit the test, press the “Standby” button  to switch the Warmer to the Standby Mode. |

| Test 9 | Manual ASTOLINE cut off („S“ models only) |
|------------------|--|
| Required Actions | <ol style="list-style-type: none"> 1. Operate the Warmer with any setpoint temperature. 2. Do <u>not</u> connect ASTOLINE to the designated appliance socket or disconnect the plug of ASTOLINE. 3. Press the „ASTOLINE“ button  to switch the Warmer to ASTOLINE On Mode. |
| Result | <p>The test is successful, when:</p> <ul style="list-style-type: none"> • The “Start” LED  flashes green. • The “Alarm” LED  flashes yellow. • The acoustic alarm signal sounds. <p>The test is <u>not</u> successful if any of the following conditions occurs:</p> <ul style="list-style-type: none"> • The “Start” LED  does not flash. • The “Alarm” LED  does not flash. • The acoustic alarm signal does not beep. |

12.1.2 Active insulation ASTOLINE

In order to ensure the safe operating condition, the recurrent test of ASTOLINE must be carried out at least every 24 months.

| Test 10 | Visual inspection |
|------------------|--|
| Required actions | <ol style="list-style-type: none"> 1. Clean ASTOLINE with an alcohol-based agent. 2. Dust ASTOLINE (groove and outer side) with talcum powder. 3. Pull the entire silicone jacket from ASTOLINE trough the hand and pay attention to: <ul style="list-style-type: none"> - unusual discolorations in the groove or on the outer surface of the profile - damages, scratches, cuts or open areas in the silicone profile 4. Check marking and the safety signs. |
| Result | <p>The test is successful, when</p> <ul style="list-style-type: none"> • No discolorations are visible • No damages are present • The safety signs are complete and legible <div style="display: flex; justify-content: space-around; align-items: center;">    </div> |

| Test 11 | Functional test |
|------------------|---|
| Required actions | Operate ASTOLINE together with the warmer ASTOTHERM PLUS. |
| Result | <p>The test is successful, when</p> <ul style="list-style-type: none"> • ASTOLINE can be switched on with the “ASTOLINE” button  • The “ASTOLINE” LED illuminates green • No alarm is indicated. |

12.2 Set up for electrical tests

For measuring the protective earth resistance, the insulation resistance and the equipment/earth leakage current, the following test set up can be used:

| Test | Measurement (True RMS) (see also IEC/EN 62353) | Use connection to electrical safety analyzer |
|-------------------------------|--|--|
| 2 | Protective earth resistance | Connection 1 and 2 |
| 3 | Insulation resistance | Connection 1 |
| 4.1 <i>optional to 4.2</i> | Equipment leakage current (alternative method) | Connection 1 (and possibly connection 2, depending on the used safety analyzer) |
| 4.2 <i>optional to 4.1</i> | Earth leakage current N.C. (direct method) | Connection 1 |
| | Earth leakage current S.F.C (direct method, N open) | |

Connection 2:
Probe to heat exchanger
(=touchable and conductive)

Connection 1:
Mains plug





Abb. 15: Test set up for measuring

| | |
|--|---|
|  | <p>In order to achieve a sufficient accurate measurement result, during the measurement of the protective earth resistance, good electrical contact with the metal of the heat exchanger must be established.</p> <p>On the top of the heat exchanger (backside) is a small bare spot to make the contact with the probe. At this point the (insulating) anodic coating of the heat exchanger is penetrated by the manufacturer's test.</p> |
|--|---|

12.3 Test protocol

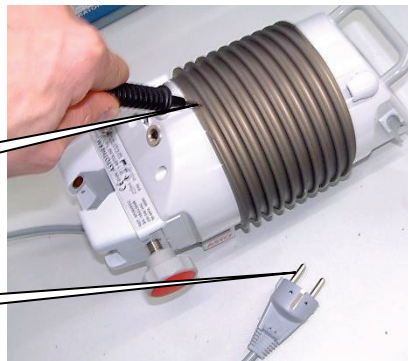
| | ASTOTHERM PLUS | ASTOLINE |
|------|----------------|----------|
| Type | | |
| SN | | |

| Test Equipment | | |
|---------------------|--|--|
| Type | | |
| SN | | |
| Date of calibration | | |

| Test 1: Visual inspection | | | P/F |
|--|---------------------|-------------------|--------|
| Labeling and markings on ASTOTHERM PLUS | | | |
| Control panel (front foil) | | | |
| Housing | | | |
| Power supply cord | | | |
| Attachment device | | | |
| Test 2: Protective earth resistance | | | |
| | Value [Ω] | Max [Ω] | P/F/NA |
| Protective earth resistance | | 0.3 | |
| Resistance potential equilization (optional) | | 0.3 | |
| Test 3: Insulation resistance | | | |
| | Value [$M\Omega$] | Min [$M\Omega$] | P/F |
| Insulation resistance | | 100 | |
| Test 4: Leakage current test either to 4.1 or 4.2 | | | |
| <input type="checkbox"/> 4.1 Equipment leakage current (alternative method) Alternative test for measurement the earth leakage current using the direct method (Test 4.2) | | | |
| | Value [mA] | Max [mA] | P/F |
| Equipment leakage current | | 1.0 | |
| <input type="checkbox"/> 4.2 Earth leakage current (direct method) Alternative test for measurement the equipment leakage current using the alternative method (Test 4.1) PE (Protective ground) open. Measure all combinations of line polarity. | | | |
| | Value [mA] | Max [mA] | P/F |
| Earth leakage current N.C | | 0.5 | |
| Earth leakage current S.F.C (N open) | | 1.0 | |

| Test 5: Temperature control and display | | | | |
|--|-------------------|-----------------|-----------------|--------------------------|
| | Value [°C] | Min [°C] | Max [°C] | P/F |
| Selected setpoint temperature T (max. 41°C) | | | | |
| Temperature measurement TT (with clinical thermometer) | | T – 0.5 | T + 0.5 | |
| Actual temperature (displayed) TD | | T – 0.3 | T + 0.3 | |
| Manual tests | | | | P/F/NA |
| Test 6: Manual excessive temperature cut off 1 (t1) | | | | |
| Test 7: Manual excessive temperature cut off 2 (t2) | | | | |
| Test 8: Manual low temperature alarm (t3) | | | | |
| Test 9: Manual ASTOLINE cut off | | | | |
| ASTOLINE | | | | P/F/NA |
| Test 10: Visual inspection ASTOLINE | | | | |
| Test 11: Functional test | | | | |
| Overall assessment | | | | |
| <i>Please mark where applicable</i> | | | | |
| No safety or functional deficiencies were detected | | | | <input type="checkbox"/> |
| No direct risk, deficiencies detected may be corrected on short term | | | | <input type="checkbox"/> |
| Equipment shall be taken out of operation until deficiencies are corrected | | | | <input type="checkbox"/> |
| Equipment does not comply – Modification / Exchange of components / Taking out of service - is recommended | | | | <input type="checkbox"/> |
| Comments | | | | |
| | | | | |
| Date | Signature | | | |
| | | | | |

13 Technical data

| | | | |
|---|---|--|------------------------------------|
| ASTOTHERM PLUS REF | AP220.. AP220S.. AP260.. AP260S.. | ..NA ..JA | |
| Electrical connection | 100 - 115 VAC 50 – 60 Hz | | |
| Fuses primary (F1 F2) | T4AH 250 V (5 x 20 mm) | | |
| Fuses secondary (F3 F4) | T0630AL 250 V (TR5 type) | | |
| Power consumption | max. 450 W | | |
| Classification (IEC/EN 60601-1) | Class I, Type B applied part is defibrillation proof | | |
| Classification (IEC/EN 60529) | IPX4 | | |
| Classification (MDD 93/42/EEC) | Class IIb | | |
| Code UMDNS | 10-447 | | |
| Code GMDN | 47616 | | |
| Regulatory class as per FDA | II | | |
| Dimensions (excl. ASTOLINE) | max. | | |
| Height | 145 mm | | |
| Width | 135 mm | | |
| Depth (incl. attachment device) | 295 mm | | |
| Weight (excl. ASTOLINE) | 2.9 kg | | |
| Operating mode | continuous operation | | |
| Permissible environmental conditions in operation | Humidity 10% to 90% not condensing | Temperature +16°C to +32°C | Pressure 700 hPa to 1060 hPa |
| In storage | 10% to 90% not condensing | -20°C to +60°C | 500 hPa to 1060 hPa |
| Selectable setpoint temperatures Standard setting by manufacturer, special setpoint temperatures are possible in the range from 36°C to 43°C | 43°C 41°C 39°C | | |
| Essential performance acc. to IEC/EN 60601-1 | Regulation of the temperature of the heat exchanger to a selectable Set-temperature between 37 °C to 43.5 °C +/- 0.5 °C | | |
| 1. Excessive temperature cut off 2. Excessive temperature cut off | if max. T _{Set} = 43°C 45.5°C (± 1°C) 46.0°C (± 1°C) | if max. T _{Set} = 41°C 42.5°C (± 0.5°C) 43.5°C (± 0.5°C) | |
| Low temperature alarm | T _{Setpoint} – 4°C (± 0.5°C) | | |
| Heating up time (22°C to 40°C) | approx. 1 minute | | |
| Self-start after power interruption up to | 5 seconds | | |
| ASTOLINE | 8 W rated power supplied with 22 VDC from ASTOTHERM PLUS | | |

14 Compliance with international standards

| Standard | Title |
|---|--|
| IEC/EN 60601-1 ANSI/AAMI ES 60601-1 CAN/CSA C22.2 No. 60601-1 | Medical electrical equipment - Part 1: General requirements for basic safety and essential performance |
| IEC/EN 60601-1-2 | Medical electrical equipment - Part 1-2: General requirements for basic safety and essential performance - Collateral standard: Electromagnetic compatibility – Requirements and tests |
| IEC/EN 60601-1-8 | Medical electrical equipment - Part 1-8: General requirements for basic safety and essential performance - Collateral Standard: General requirements, tests and guidance for alarm systems in medical electrical equipment and medical electrical systems. |
| ASTM F 2172-02 | Standard Specification for Blood/Intravenous Fluid/Irrigation Fluid Warmers |

15 Ordering information, accessories and consumables

You can order an **ASTOTHERM PLUS** Warmer using the following order numbers:

| REF (Order-No.) | Description |
|--------------------|---|
| AP220xx | For 4 mm infusion line, without ASTOLINE, Heat Protection Sleeve optional |
| AP220Sxx | For 4 mm infusion line, with ASTOLINE AL222, with Heat Protection Sleeve |
| AP260xx | For 6.8 mm infusion line, without ASTOLINE, with Heat Protection Sleeve |
| AP260Sxx | For 6.8 mm infusion line, with ASTOLINE AL260, with Heat Protection Sleeve |

| | |
|-------------|---|
| xx = | EU 230 - 240 VAC, CEE 7/7 (Schuko) Plug |
| | CH 230 - 240 VAC, Swiss Plug |
| | DK 230 - 240 VAC, Danish Plug |
| | CN 230 - 240 VAC, China Plug |
| | UK 230 - 240 VAC, BS Plug incl. 13A fuse |
| | AU 230 - 240 VAC, Australian Plug |
| | NA 100 - 115 VAC, Hospital Grade Plug |
| | JA 100 - 115 VAC, Hospital Grade Plug |

Accessory:

| REF (Order-No.) | Description |
|--------------------|--|
| AL222 | ASTOLINE suitable for infusion lines Ø 4 mm , length: 130 cm |
| AL260 | ASTOLINE suitable for infusion lines Ø 6.8 mm , length: 130 cm |
| WM226 | Heat Protection Sleeve suitable for all models |

Suitable Consumables:

| REF (Order-No.) | Description |
|--------------------|--|
| IFT30460 | ASTOTUBE , sterile infusion extension made from PVC, outer diameter Ø 4 mm (suitable for AP220/220S), filling volume approx. 40 ml |
| IFT30410 | ASTOTUBE , sterile infusion extension made from PVC, outer diameter Ø 6.8 mm (suitable for AP260/260S), filling volume approx. 89 ml |

We reserve the right to modify design and technical data without notice.

16 Guidelines and manufacturer's declaration

| Guidance and manufacturer's declaration - electromagnetic emissions | | | |
|---|---|--|--|
| ASTOTHERM PLUS is intended for use in the electromagnetic environment specified below. The customer or user of the ASTOTHERM PLUS should assure that it is used in such an environment. | | | |
| Emission test | Compliance | Electromagnetic environment - guidance | |
| RF emissions CISPR 11/EN 55011 | Group 1 | ASTOTHERM PLUS uses RF energy only for its internal function. Therefore, its RF emissions are very low and are not likely to cause interference in nearby electronic equipment. | |
| RF emissions CISPR 11/EN 55011 | Class A | The emissions characteristics of this equipment make it suitable for use in industrial areas and hospitals (CISPR 11 class A). If it is used in a residential environment (for which CISPR 11 class B is normally required) this equipment might not offer adequate protection to radio-frequency communication services. The user might need to take mitigation measures, such as relocating or re-orienting the equipment. | |
| Harmonic emissions IEC/EN 61000-3-2 | Class A | | |
| Voltage fluctuations / flicker emissions IEC/EN 61000-3-3 | Complies | | |
| Guidance and manufacturer's declaration - electromagnetic immunity | | | |
| The ASTOTHERM PLUS is intended for use in the electromagnetic environment specified below. The customer or user of the ASTOTHERM PLUS should assure that it is used in such an environment. | | | |
| Immunity test | Test level | Compliance level | Electromagnetic environment - guidance |
| Electrostatic discharge (ESD) IEC/EN 61000-4-2 | ± 8 kV contact ± 2 kV, ± 4 kV, ± 8 kV, ± 15 kV air | in compliance | Floors should be wood, concrete or ceramic tile. If floors are covered with synthetic material, the relative humidity should be at least 30%. |
| Electrical fast transient/bursts IEC/EN 61000-4-4 | ± 2 kV 100 kHz repetition frequency | in compliance | Mains power quality should be that of a typical commercial or hospital environment. |
| Surge IEC/EN 61000-4-5 | ± 0.5 kV, ± 1 kV Line-to-line ± 0.5 kV, ± 1 kV, ± 2 kV Line- to-ground | in compliance | Mains power quality should be that of a typical commercial or hospital environment. |
| Voltage dips IEC/EN 61000-4-11 | 0 % U _T ; 0.5 cycle At 0°, 45°, 90°, 135°, 180°, 225°, 270° and 315° 0 % U _T ; 1 cycle and 70 % U _T ; 25/30 cycles Single phase: at 0° | in compliance | Mains power quality should be that of a typical commercial or hospital environment. If the user of the ASTOTHERM PLUS requires continued operation during power mains interruptions, it is recommended that the ASTOTHERM PLUS be powered from an uninterruptible power supply or a battery. |
| Voltage interruptions IEC/EN 61000-4-11 | 0 % U _T ; 250/300 cycle | in compliance | |
| Rated power frequency magnetic fields IEC/EN 61000-4-8 | 30 A/m 50 Hz or 60 Hz | in compliance | Power frequency magnetic fields should be at levels characteristic of a typical commercial or hospital environment. |
| NOTE U _T is the AC mains voltage prior to application of the test level. | | | |

| Guidance and manufacturer's declaration - electromagnetic immunity | | | |
|--|---|-------------------------|---|
| The ASTOTHERM PLUS is intended for use in the electromagnetic environment specified below. The customer or user of the ASTOTHERM PLUS should assure that it is used in such an environment. | | | |
| Immunity test | Test level | Compliance level | Electromagnetic environment – guidance Recommended separation distance |
| Conducted disturbances induced by RF fields IEC/EN 61000-4-6 | 3 Vrms 0.15 MHz to 80 MHz 6 Vrms in ISM bands between 0.15 MHz and 80 MHz 80 % AM at 1 kHz | in compliance | $d = 1.2\sqrt{P}$ |
| Radiated RF EM fields IEC/EN 61000-4-3 | 3 V/m 80 MHz to 2.7 GHz 80 % AM at 1 kHz | in compliance | $d = 1.2\sqrt{P}$ 80 MHz to 800 MHz $d = 2.3\sqrt{P}$ 800 MHz to 2.7 GHz |
| Portable and mobile RF communications equipment should be used no closer to any part of the ASTOTHERM PLUS, including cables, than the recommended separation distance calculated from the equation applicable to frequency of the transmitter. | | | |
| Where P is the maximum output power rating of the transmitter in watts (W) according to the transmitter manufacturer and "d" is the recommended separation distance in meters (m). Field strengths from fixed RF transmitters, as determined by an electromagnetic site survey, ^a should be less than the compliance level in each frequency range ^b . Interference may occur in the vicinity of equipment marked with the following symbol: | | | |
|  | | | |
| NOTE1. At 80 MHz and 800 MHz, the higher frequency range applies. | | | |
| NOTE2. These guidelines may not apply in all situations. Electromagnetic propagation is affected by absorption and reflection from structures, objects and people. | | | |
| ^a Field strengths from fixed transmitters, such as base stations for radio (cellular/cordless) telephones and land mobile radios, amateur radio, AM and FM radio broadcast and TV broadcast cannot be predicted theoretically with accuracy. To assess the electromagnetic environment due to fixed RF transmitters, an electromagnetic site survey should be considered. If the measured field strength in the location in which the ASTOTHERM PLUS is used exceeds the applicable RF compliance level above, the ASTOTHERM PLUS should be observed to verify normal operation. If abnormal performance is observed, additional measures may be necessary, such as reorienting or relocating the ASTOTHERM PLUS. | | | |
| ^b Over the frequency range 150 kHz to 80 MHz, field strength should be less than 3 V/m. | | | |

| Recommended separation distances between Portable and mobile RF communications equipment and the ASTOTHERM PLUS | | | |
|---|--|--|---|
| The ASTOTHERM PLUS is intended for use in the electromagnetic environment in which radiated RF disturbances are controlled. The customer or user of the ASTOTHERM PLUS can help prevent electromagnetic interference by maintaining a minimum distance between portable and mobile RF communications equipment (transmitters) and the ASTOTHERM PLUS as recommended below, according to the maximum output power of the communications equipment. | | | |
| Rated maximum output power of transmitter (W) | Separation distance according to frequency of transmitter (m) | | |
| | 150 kHz to 80 MHz $d = 1.2\sqrt{P}$ | 80 MHz to 800 MHz $d = 1.2\sqrt{P}$ | 800 MHz to 2.7 GHz $d = 2.3\sqrt{P}$ |
| 0.01 | 0.12 | 0.12 | 0.23 |
| 0.1 | 0.38 | 0.38 | 0.73 |
| 1 | 1.2 | 1.2 | 2.3 |
| 10 | 3.8 | 3.8 | 7.3 |
| 100 | 12 | 12 | 23 |
| For transmitters rated at maximum output power not listed above, the recommended separation distance d in meters (m) can be estimated using the equation applicable to the frequency of the transmitter, where P is the maximum output power rating of the transmitter in Watts (W) according to the transmitter manufacturer. | | | |
| NOTE 1: The compliance level between 80 MHz and 2.7 GHz is intended to decrease the likelihood that mobile/portable communication equipment could cause interference if it is inadvertently brought into patient areas. For this reason, an additional factor of 10/3 is used in calculating the recommended separation distance for transmitters in this frequency range. | | | |
| NOTE 2: These guidelines may not apply in all situations. Electromagnetic propagation is affected by absorption and reflection from structures, objects and people. | | | |

